

Booster Kit: Thermo-Shield

assembly guide

version 221222



Thermo-Shield Dimensions:

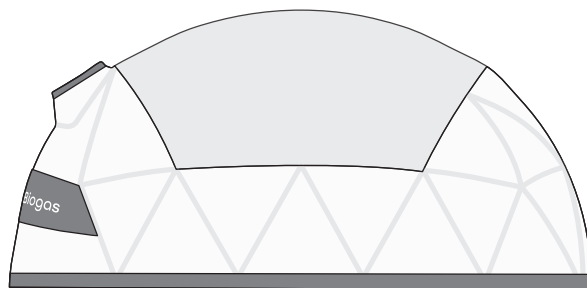

Frame & Cover: 3.0 x 2.0 x 1.4m

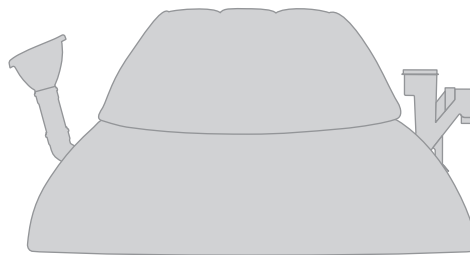
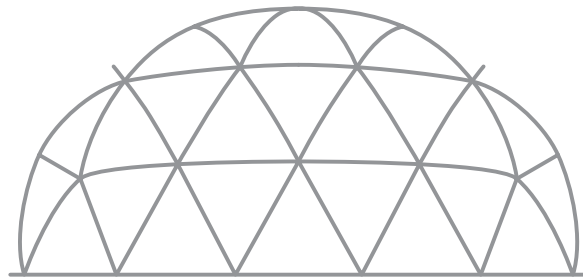

Insulation Layer: 2.2 x 1.2m

Ground Sheet: 3.6 x 2.4m

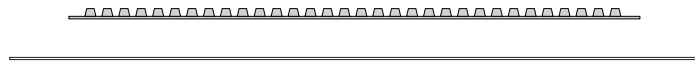

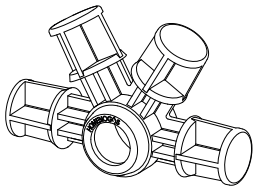

4-way connector **x14**

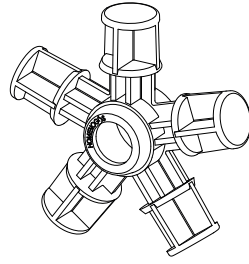

5-way connector **x6**

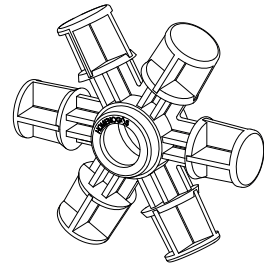

6-way connector **x17**

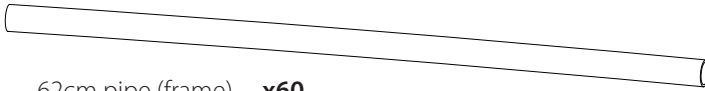

62cm pipe (frame) **x60**



31cm pipe (side brace) **x2**



55cm pipe (frame) **x30**

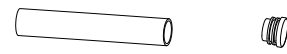

15cm pipe (side brace) **x2**
pipe insert (side brace) **x2**

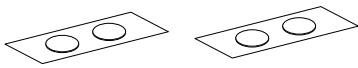

orientation marking stickers **x4**

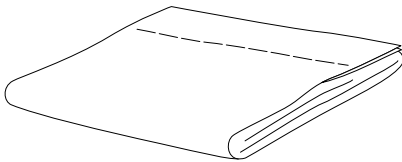

ground sheet (black)

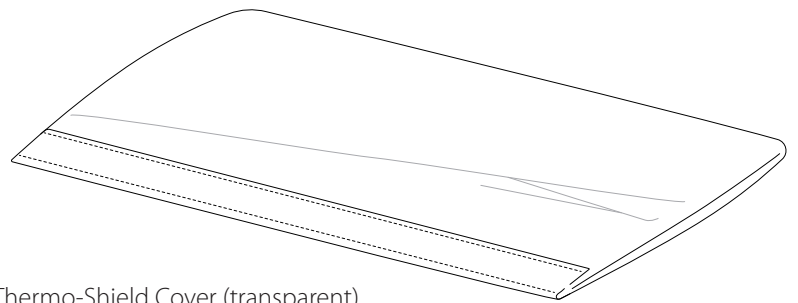

Thermo-Shield Cover (transparent)

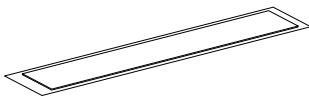

duct tape strips **x14**

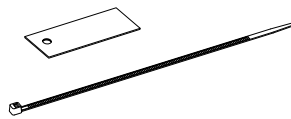

sink velcro strip **x4**
zip-tie (for sink velcro) **x4**



fertilizer pipe support strap

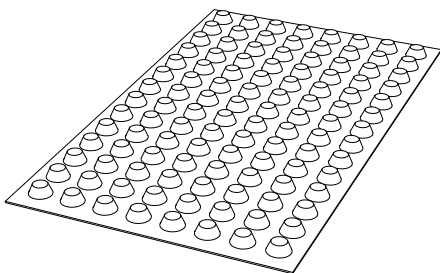

insulation sheets **x9**



U-stake **x4**



cover peg **x6**

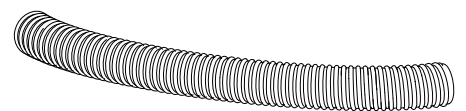

fertilizer outlet pipe (60cm)

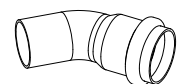

fertilizer outlet elbow

System already assembled/in use

Go to page 6

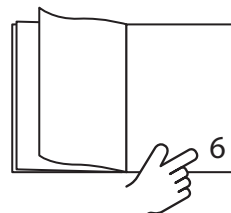
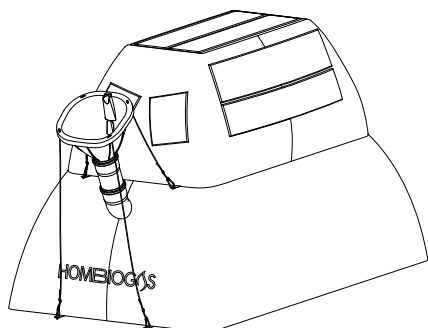

- ① Place Groundsheet
- ② Install Thermo-Regulator (If available. Refer Thermo-Regulator Manual)
- ③ Assemble & install Thermo-Shield

System not yet assembled

Go to page 7

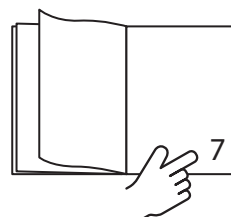

- ① Select site (Refer Homebiogas User Manual)
- ② Place Groundsheet & Insulation sheets
- ③ Install & activate system (Refer Homebiogas User Manual)
- ④ Install Thermo-Regulator (If available. Refer Thermo-Regulator Manual)
- ⑤ Assemble & install Thermo-Shield

i The Groundsheet prevents growth of vegetation under the Thermo-Shield

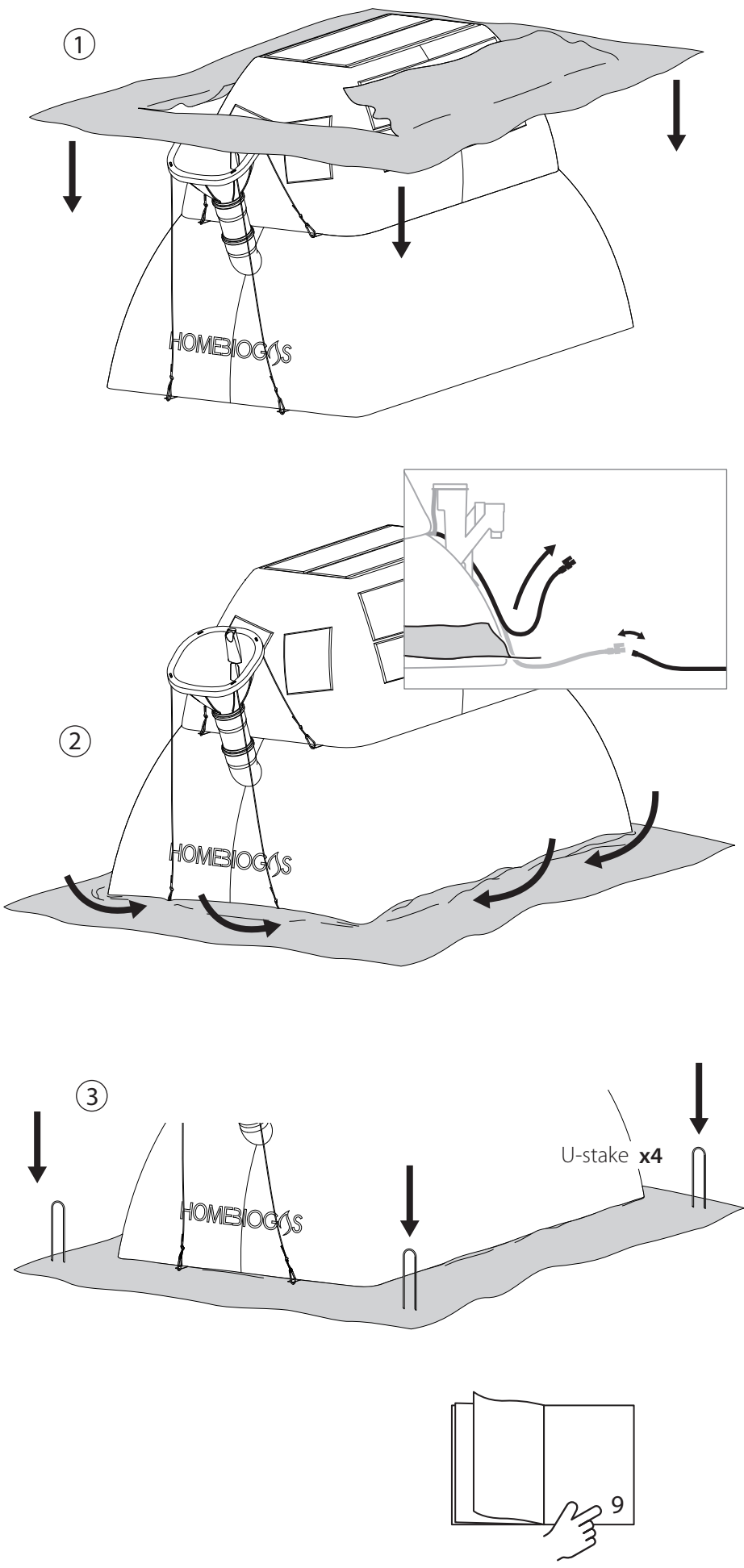
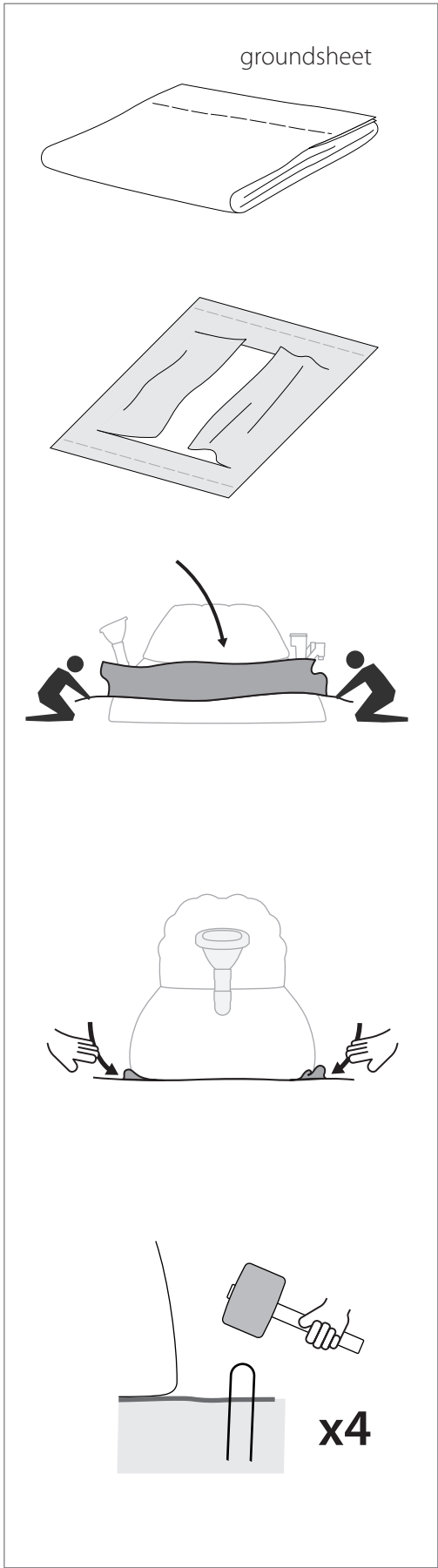

insulation sheet **x9**
(3x 70cm, 6x 75cm)

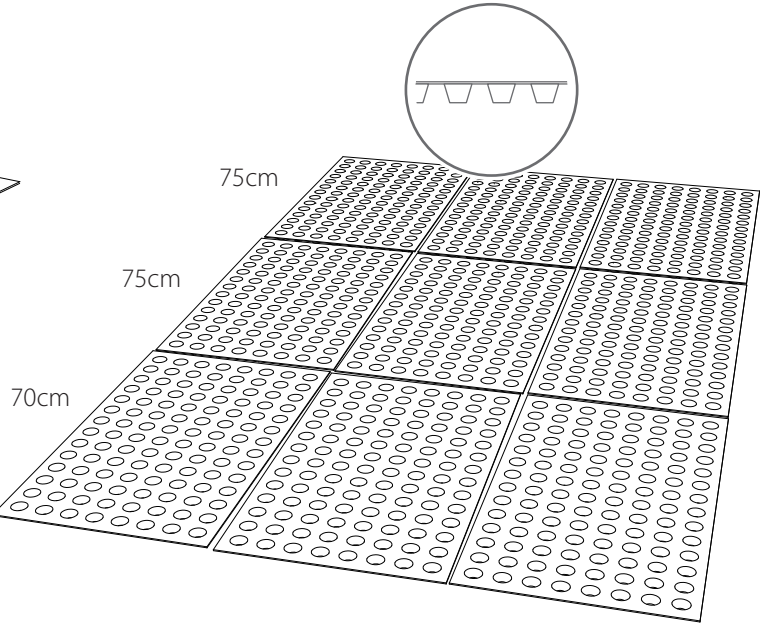
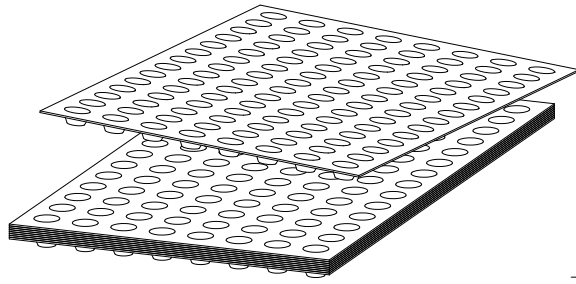

! place 3x shorter (70cm) sheets in the same row

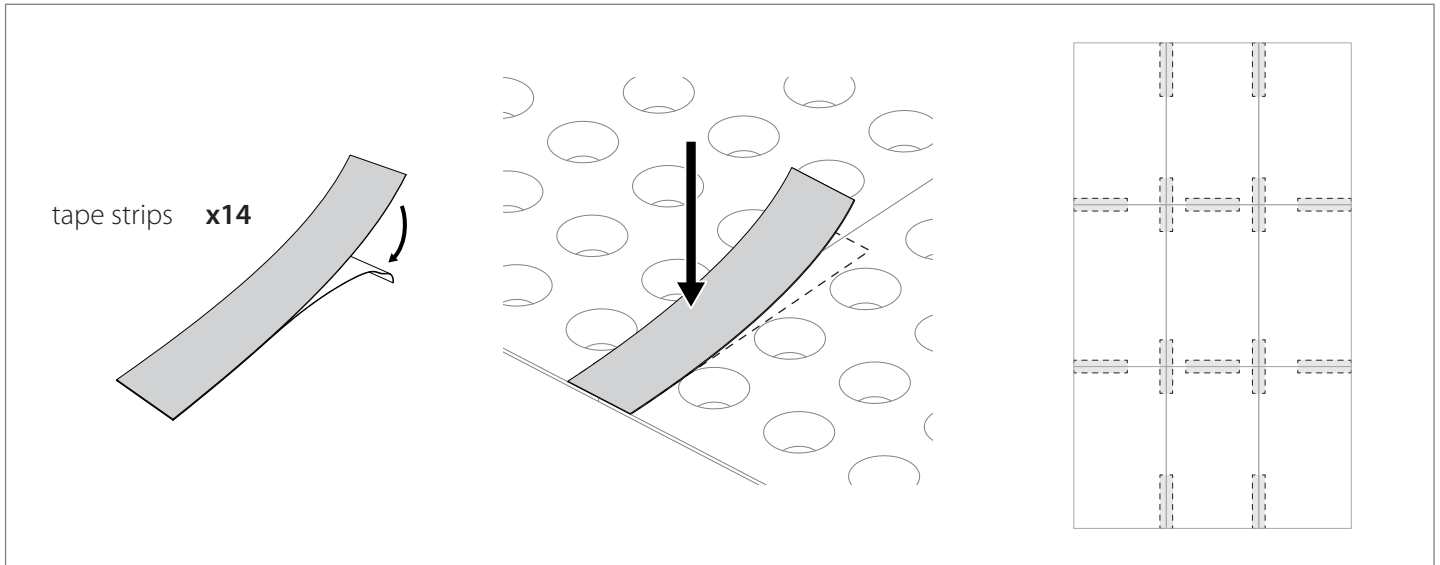

tape strips **x14**

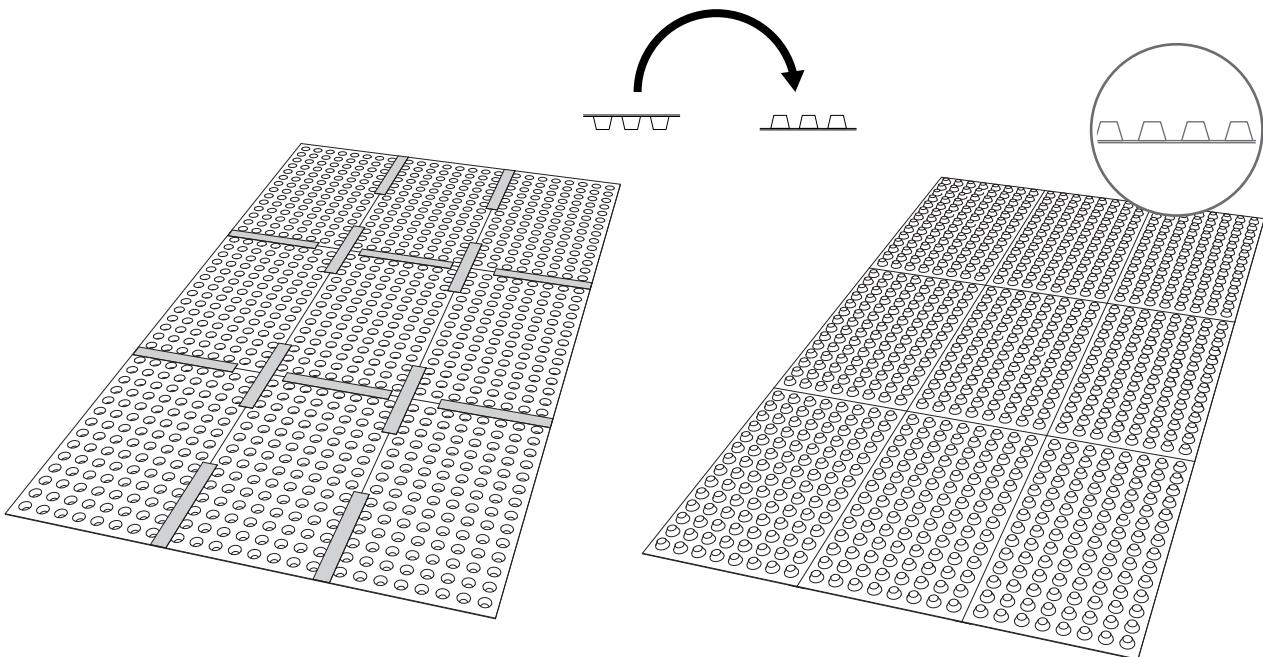

groundsheet

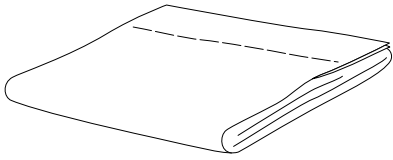

i The Groundsheet prevents growth of vegetation under the Thermo-Shield

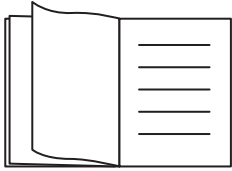
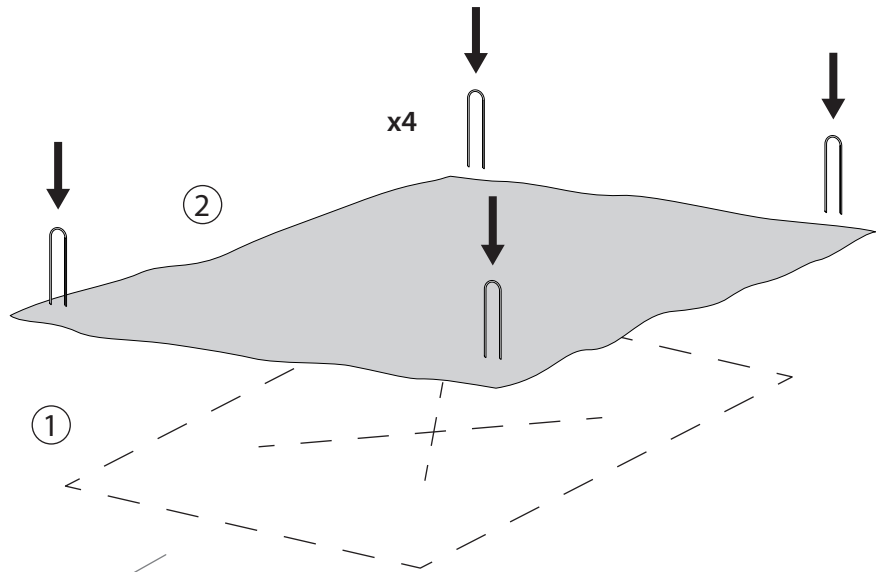

Select site according to **Homebiogas User Manual**

i Insulation layer prevents heat loss to the ground

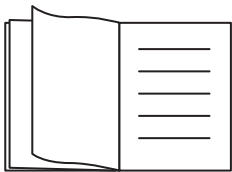
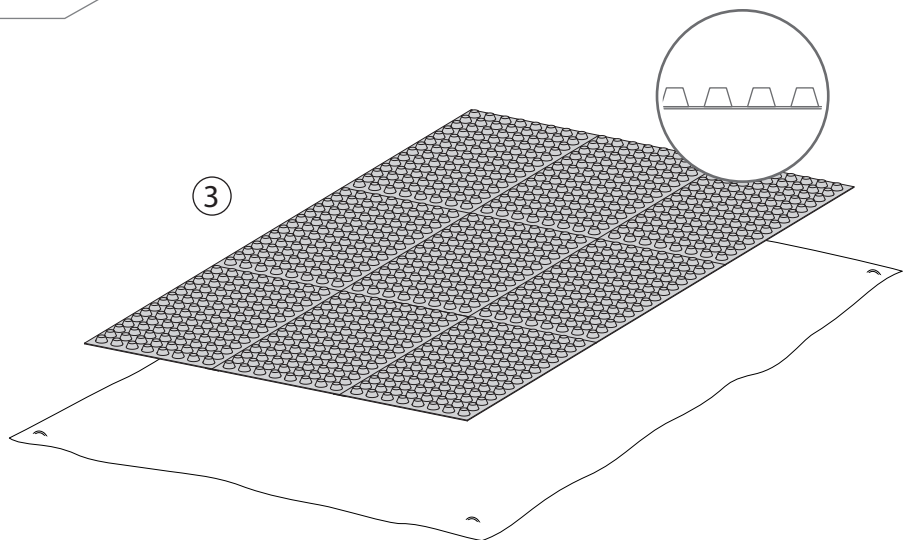

Assemble system according to **Homebiogas User Manual**

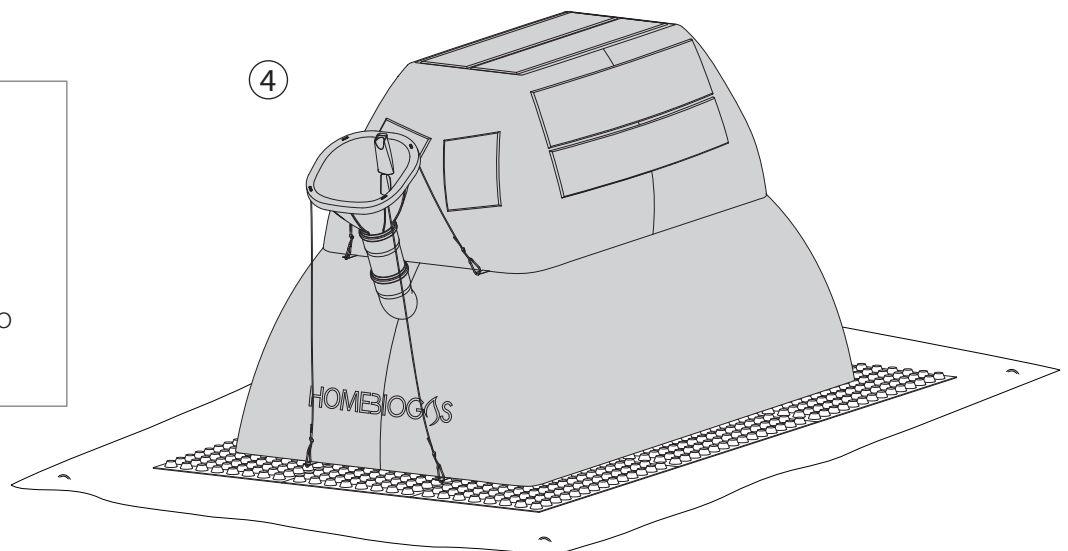

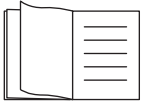

First install Thermo-Regulator, if available, according to user manual provided

1

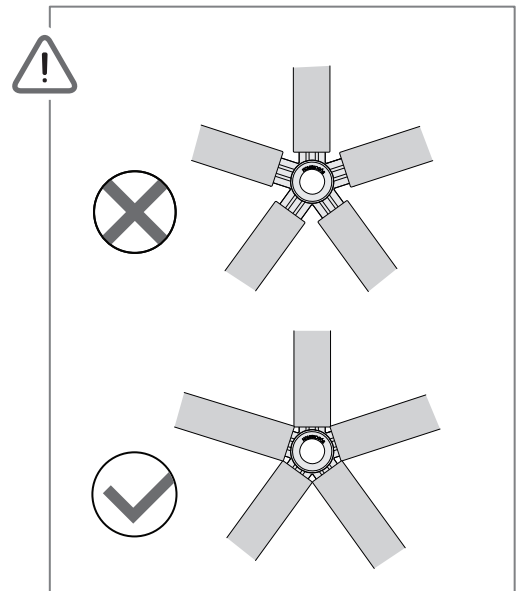
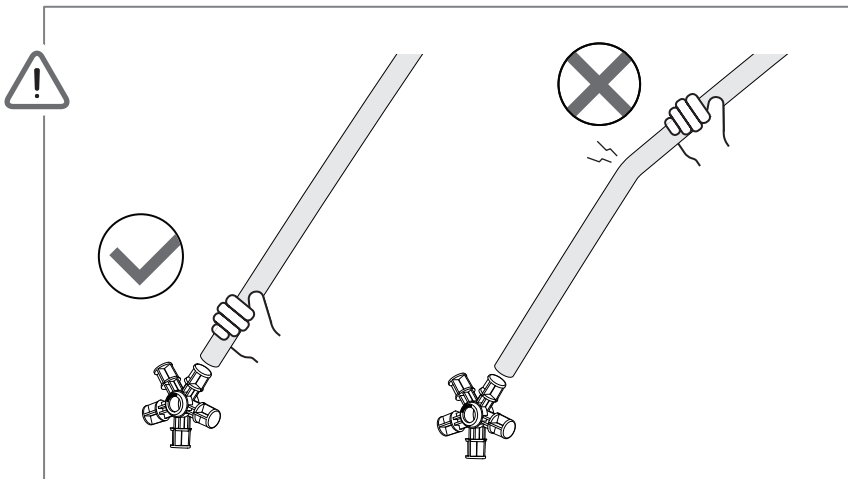
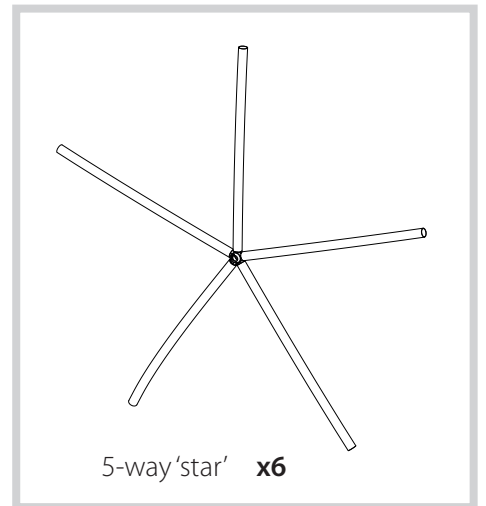
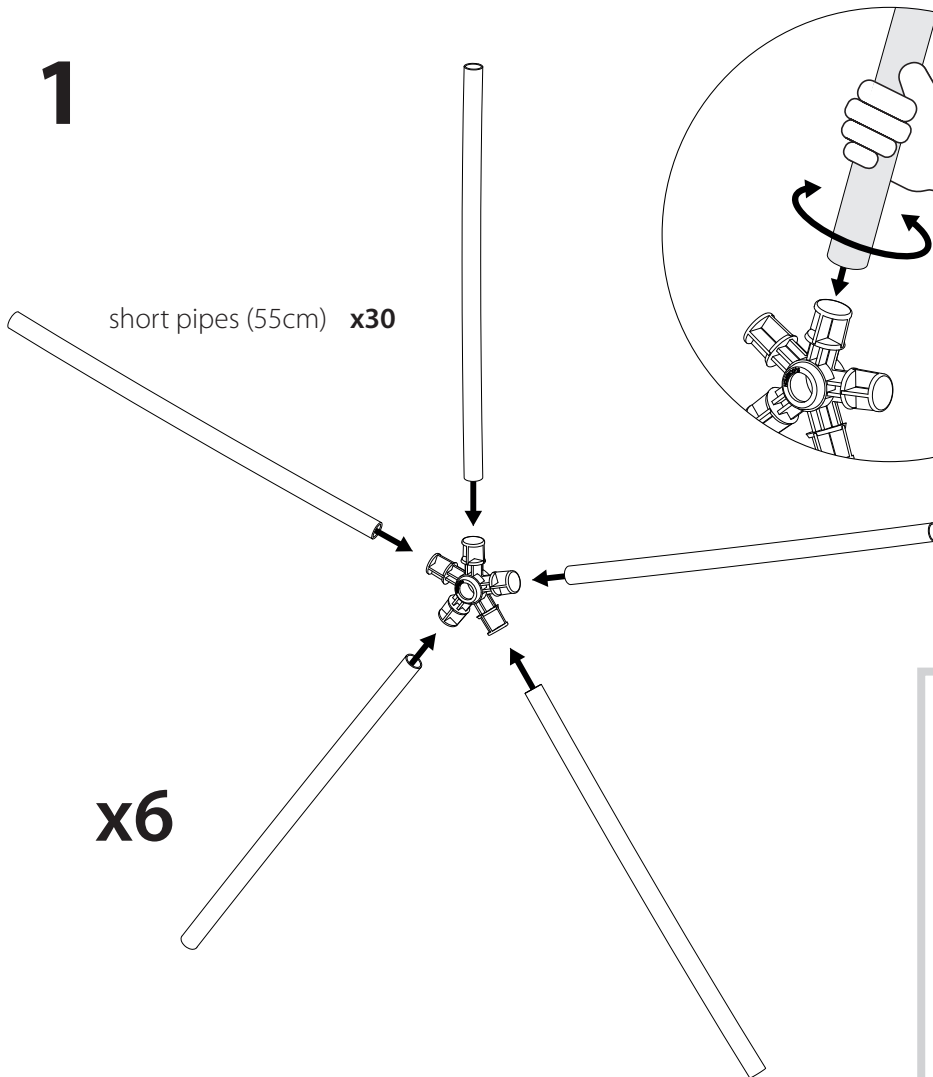

2

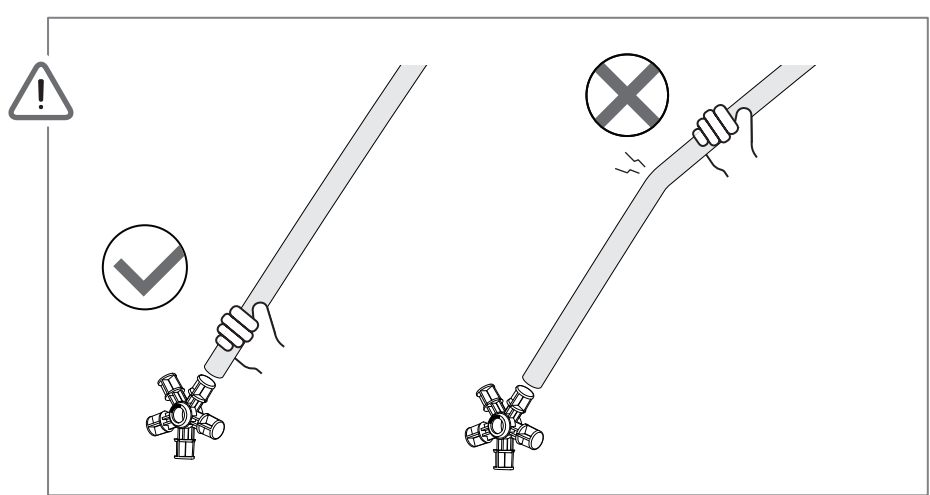
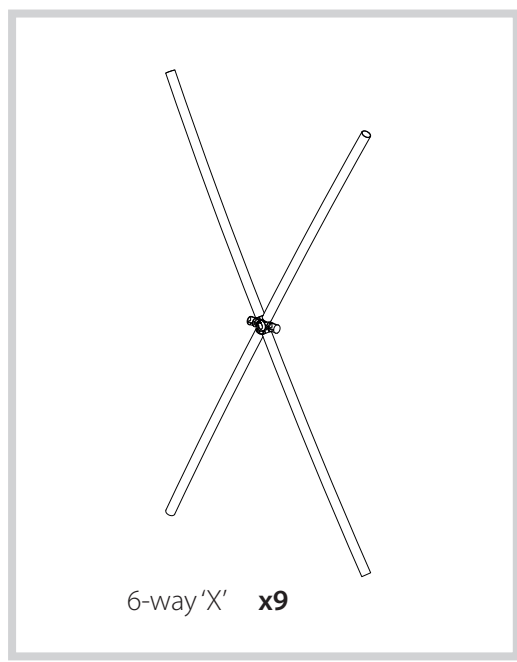
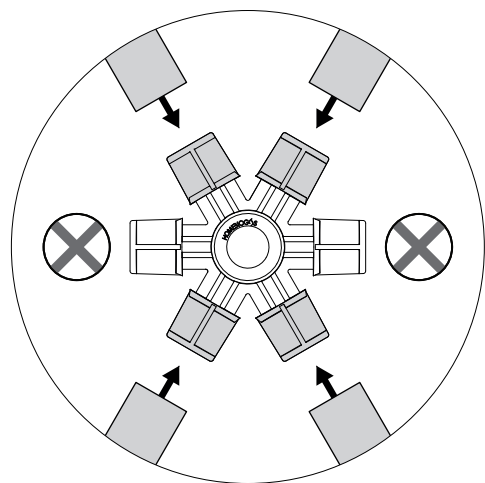
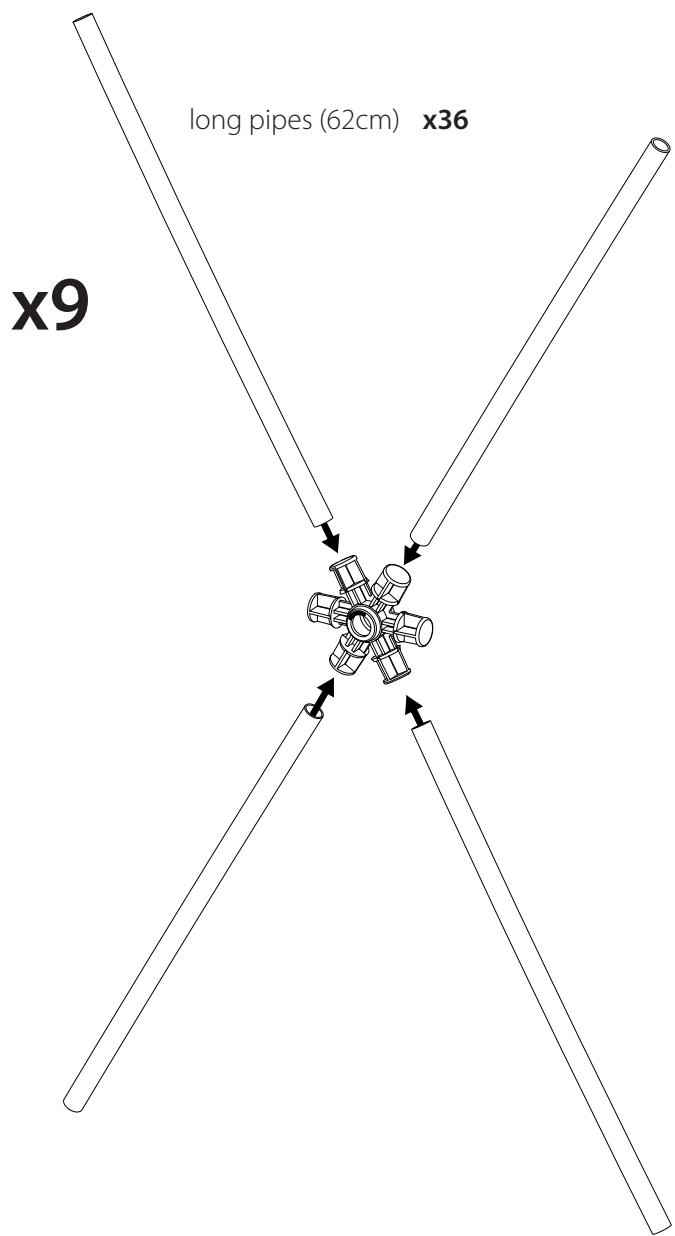

3

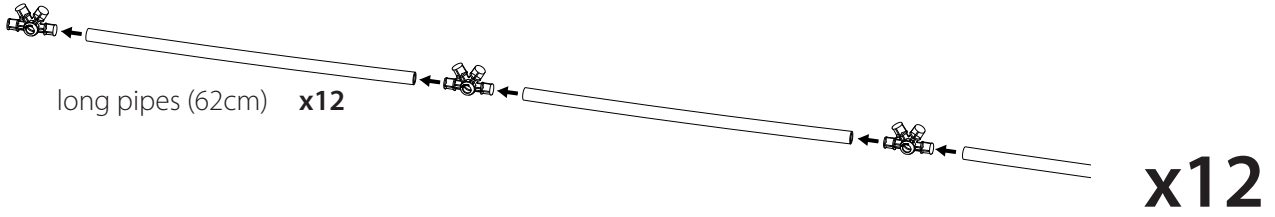
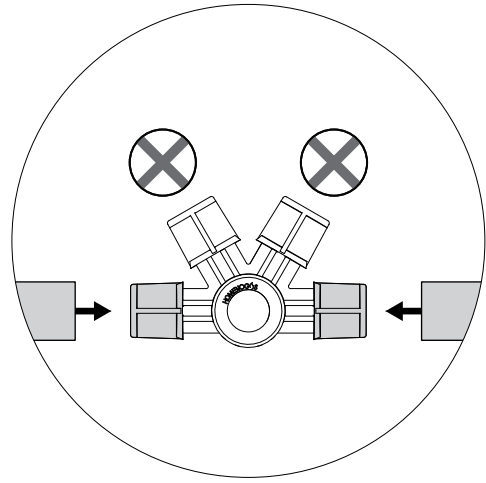

4



HomeBiogas logo facing **outside**

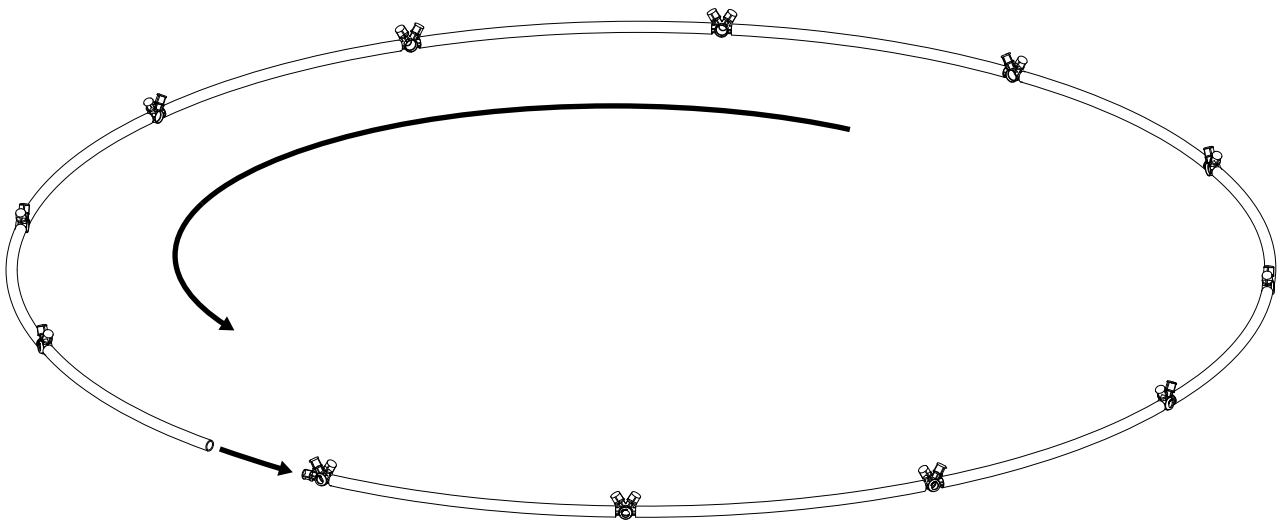
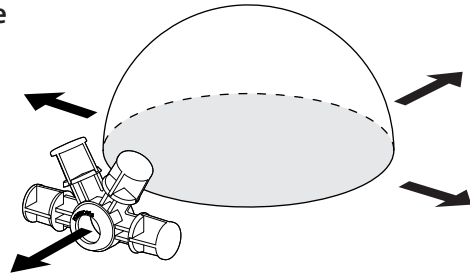

5

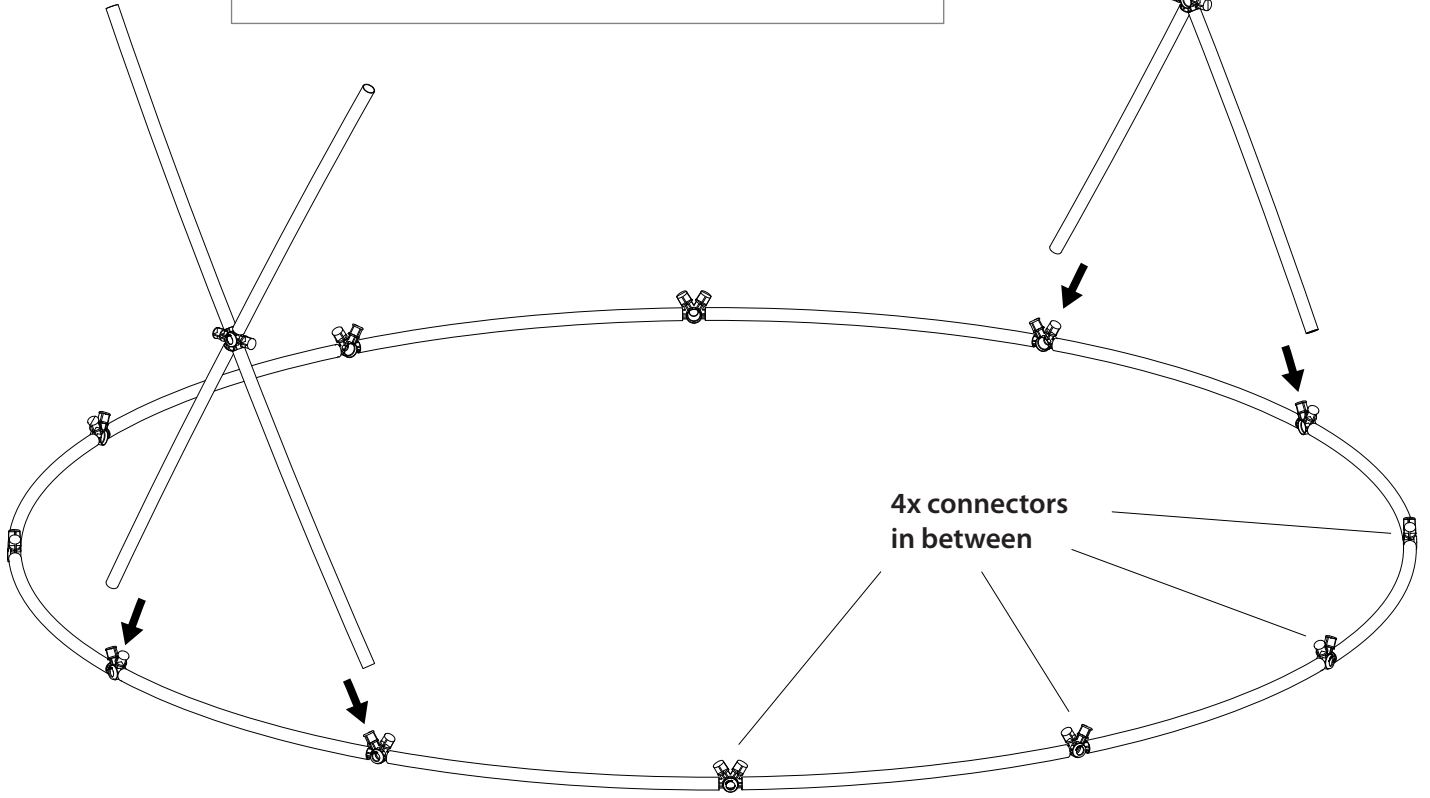
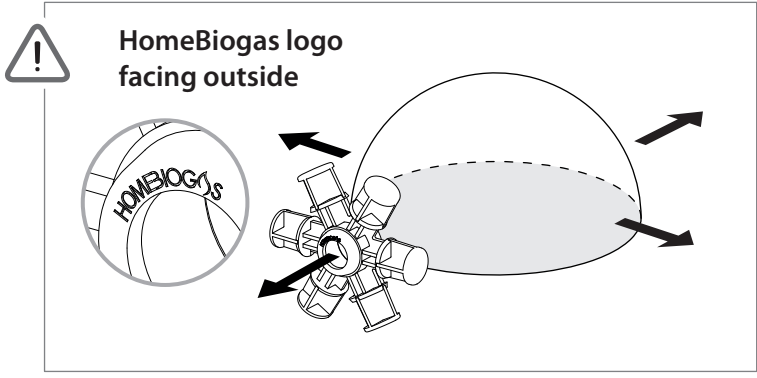

6

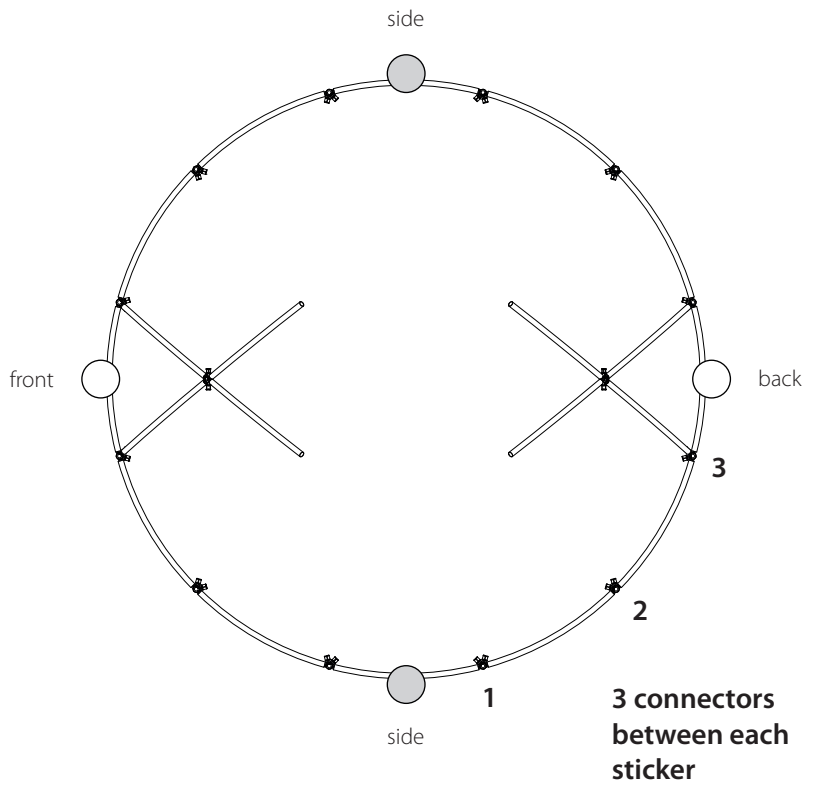
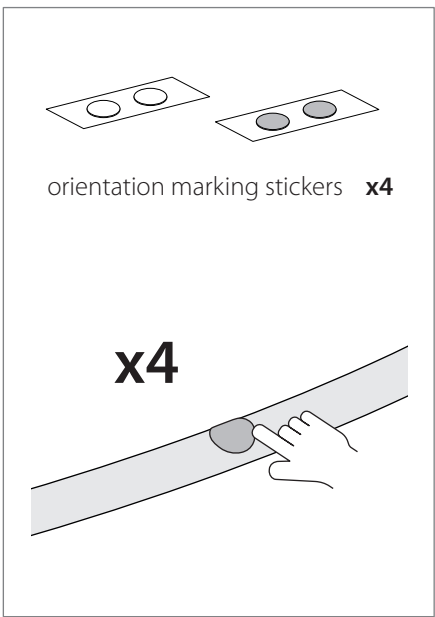

7

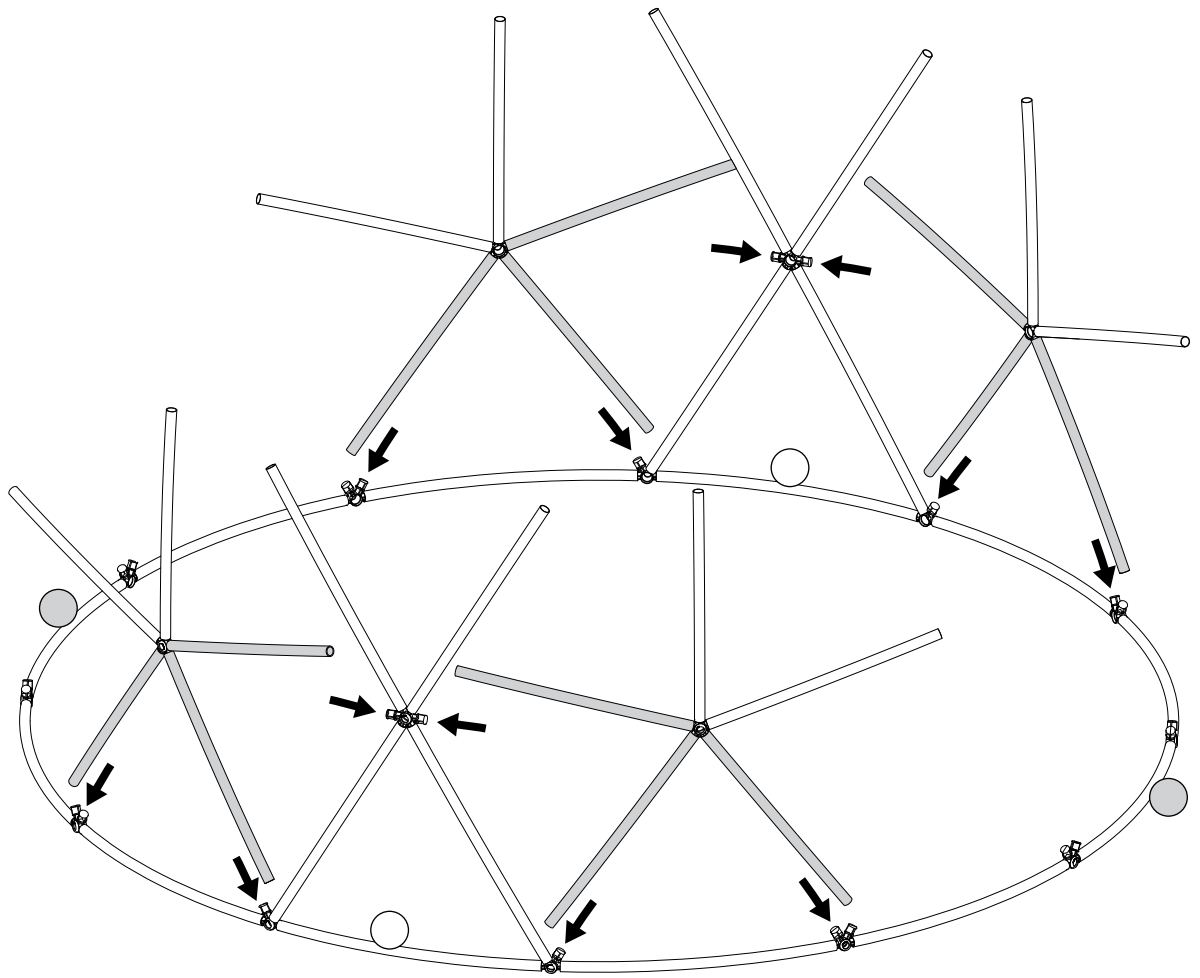
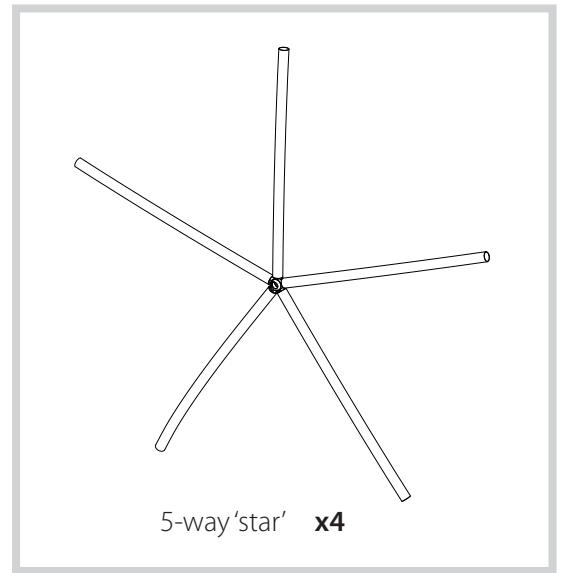

8

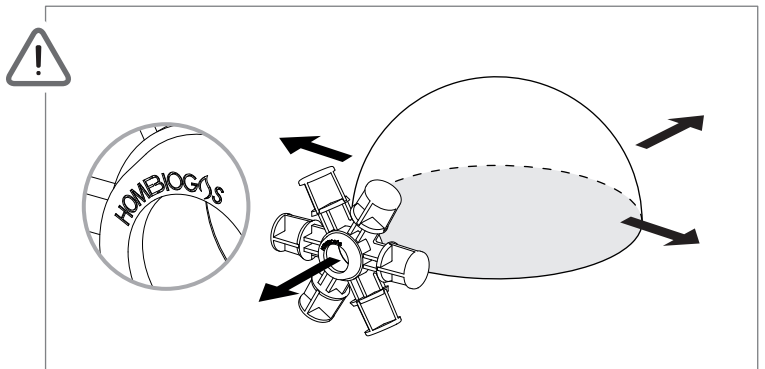
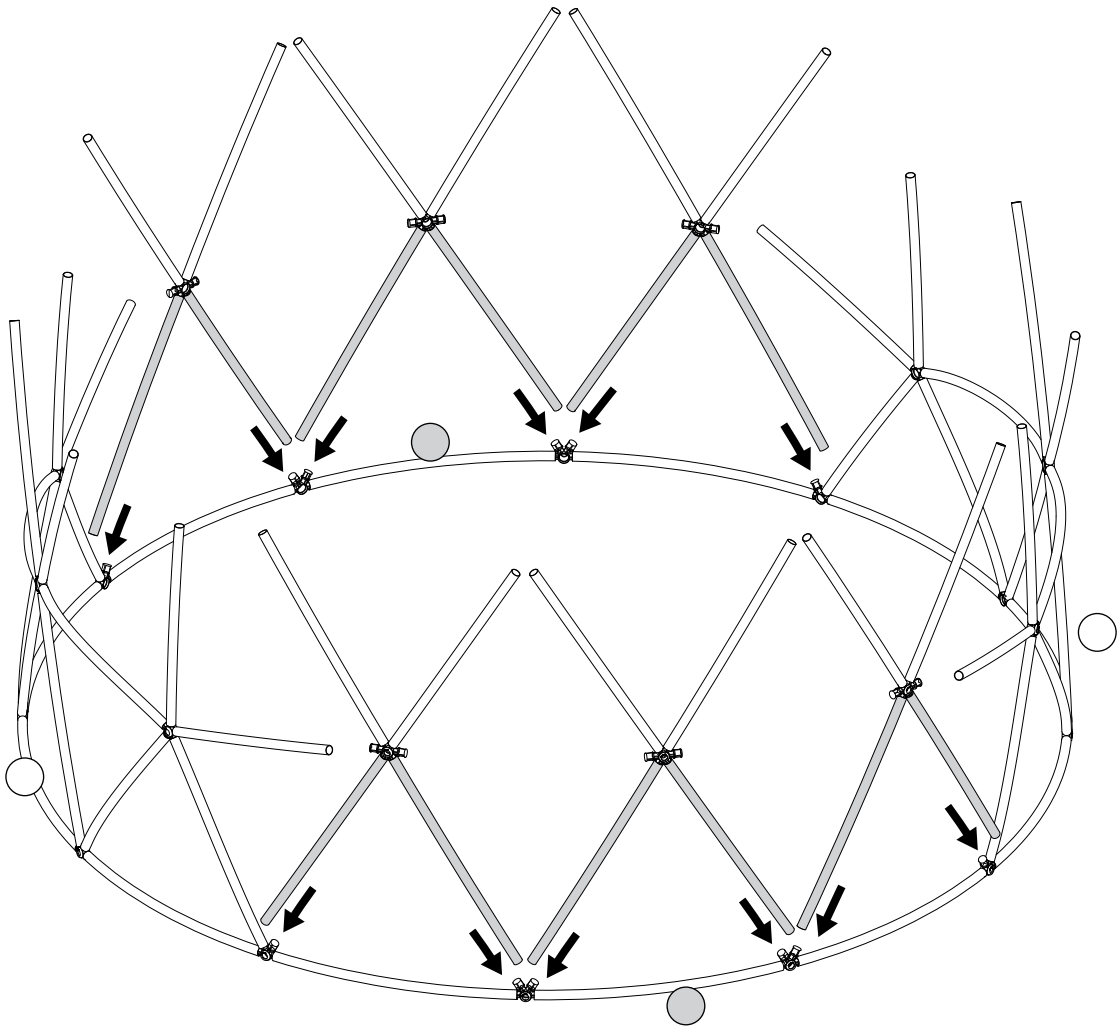
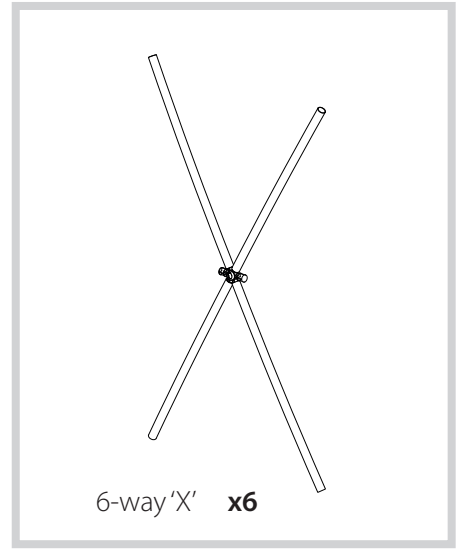

9

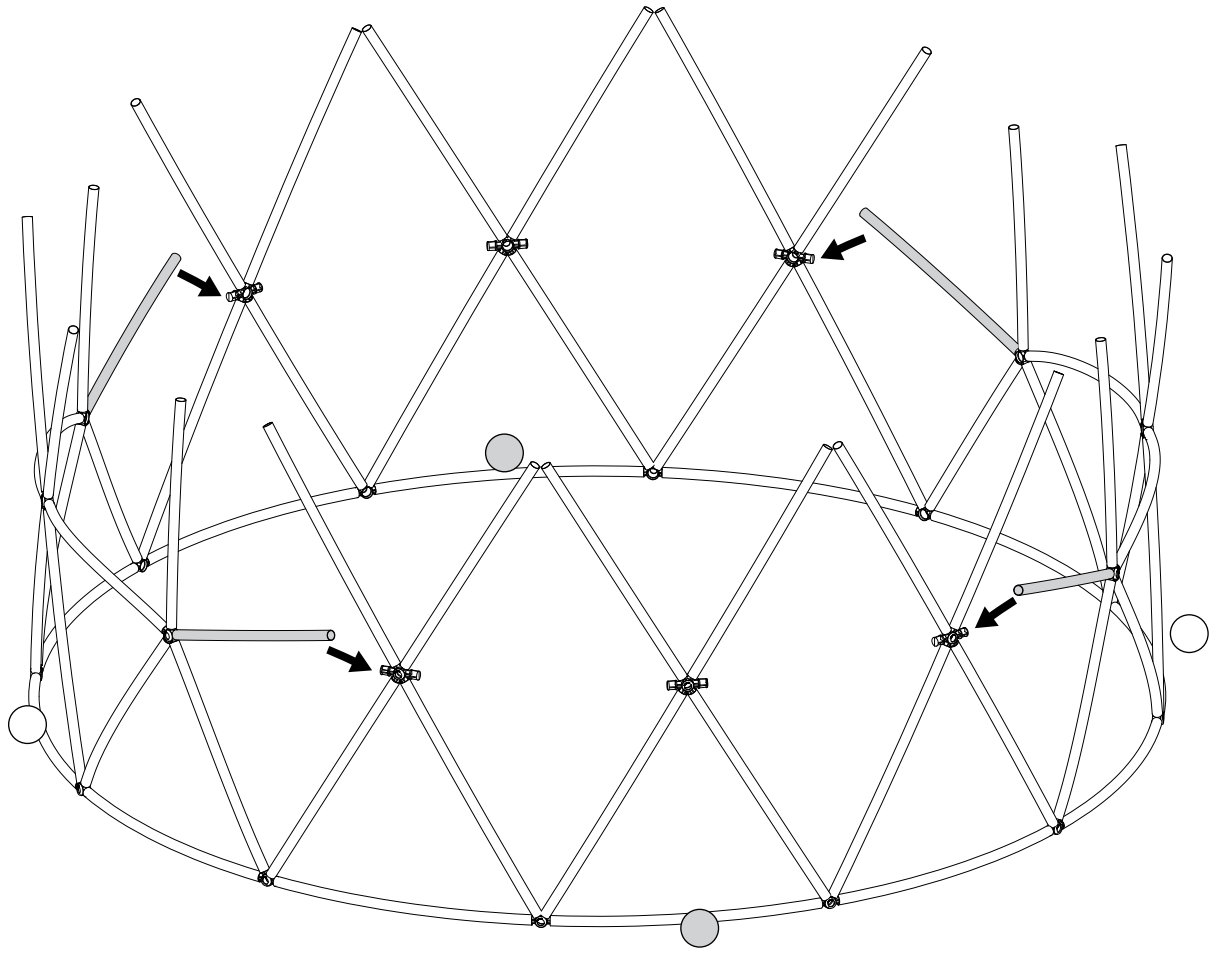

10

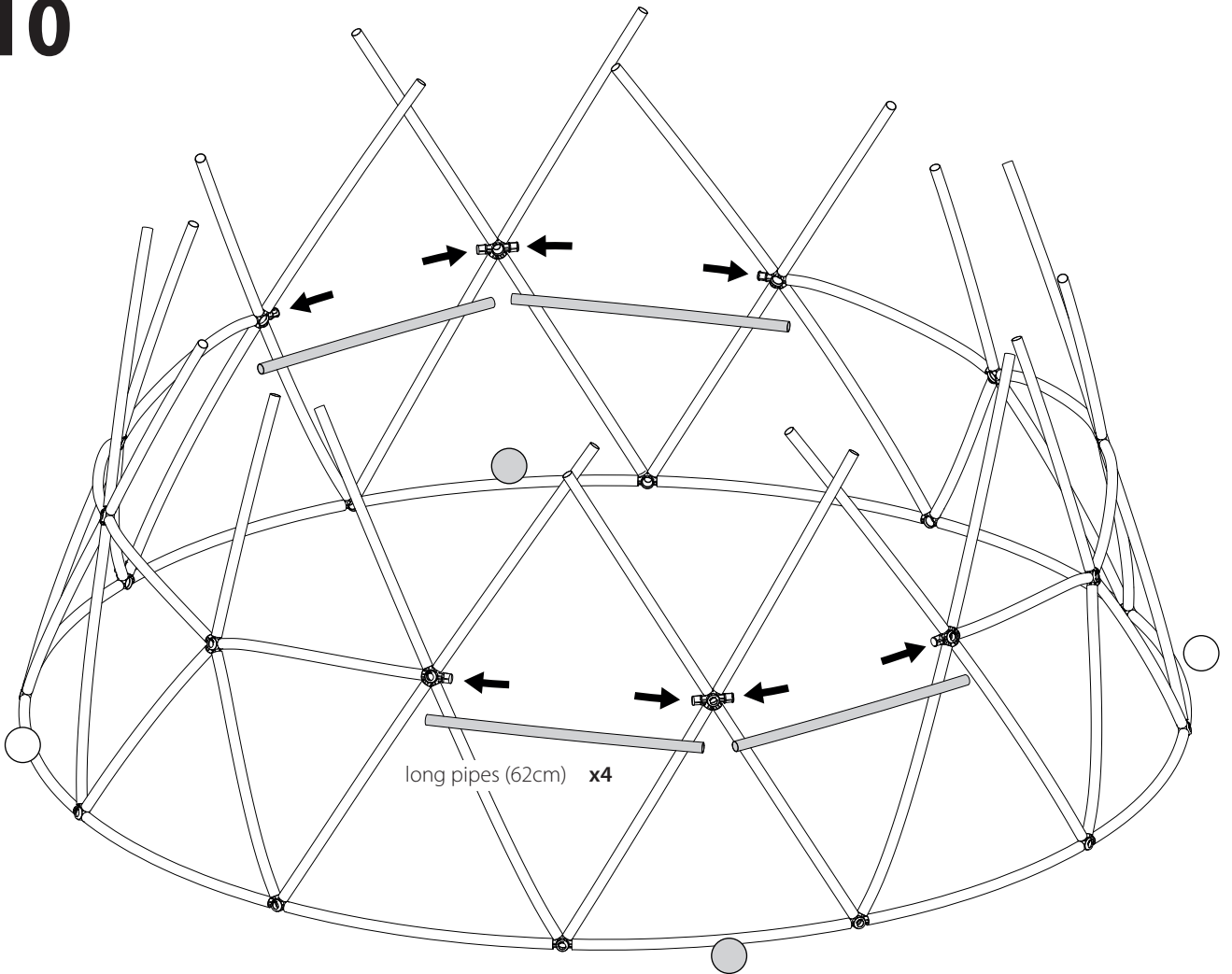

11

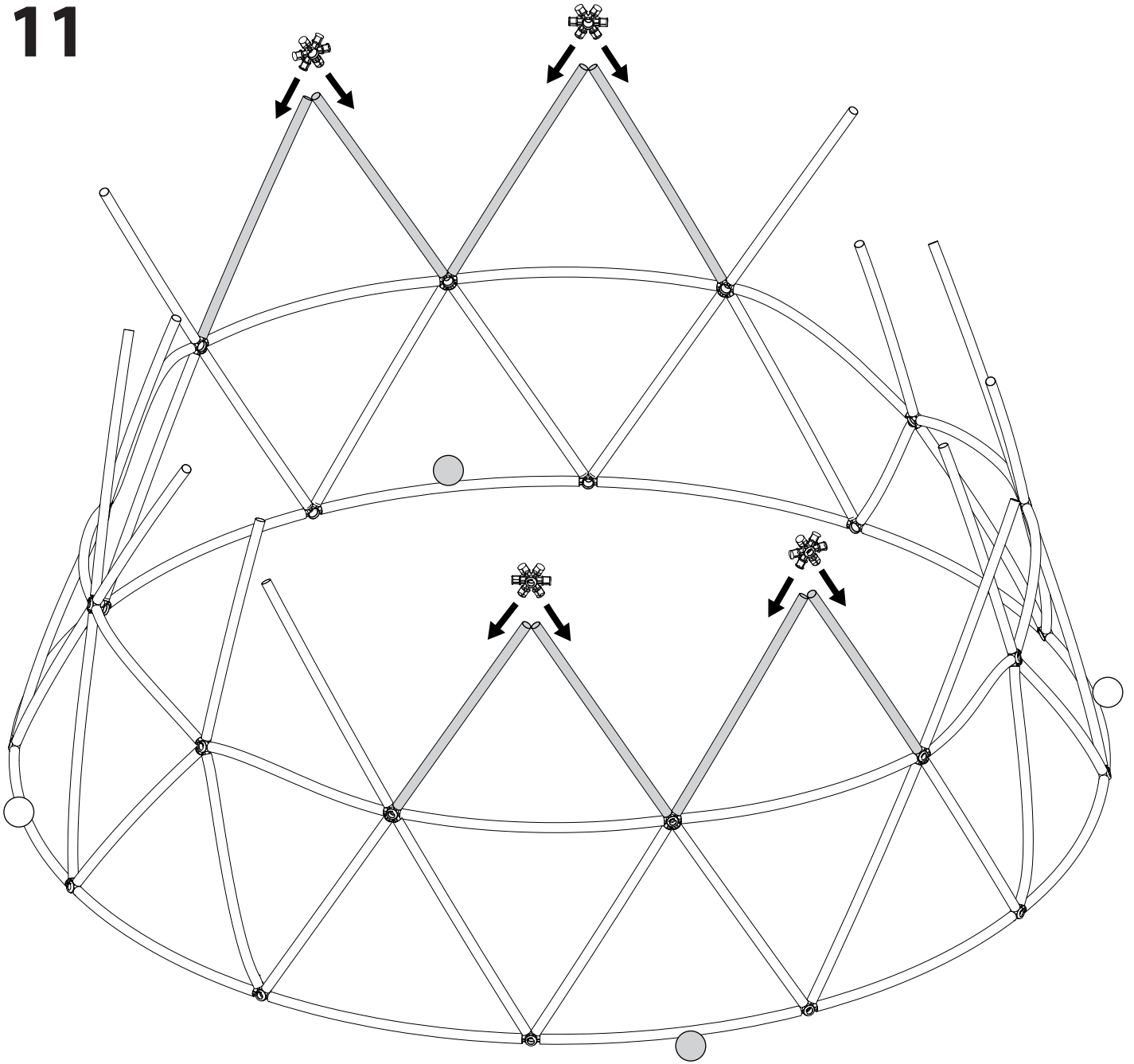

12

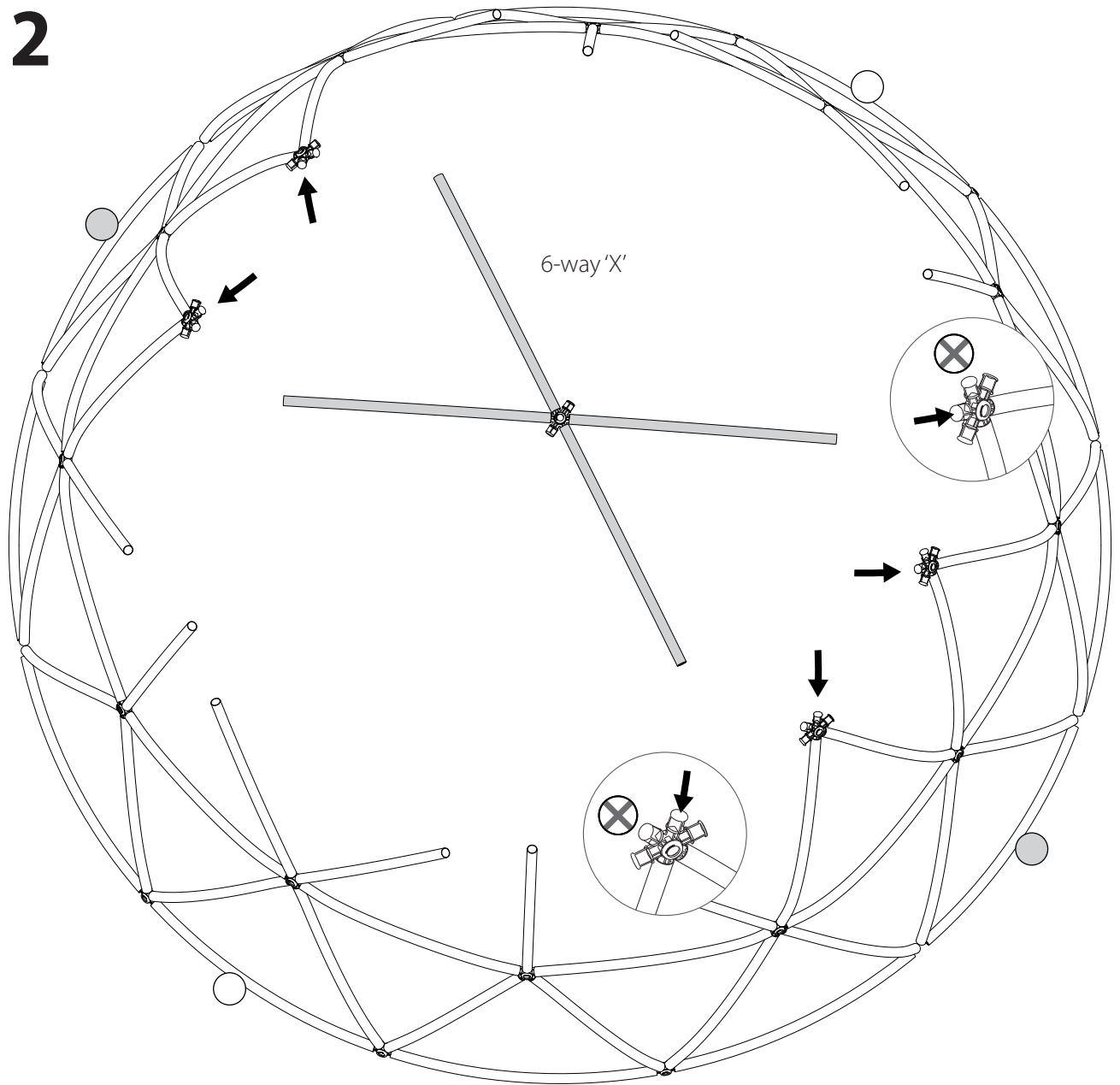

do not over-bend pipes
- this can damage
connectors

13

5-way 'star' x2

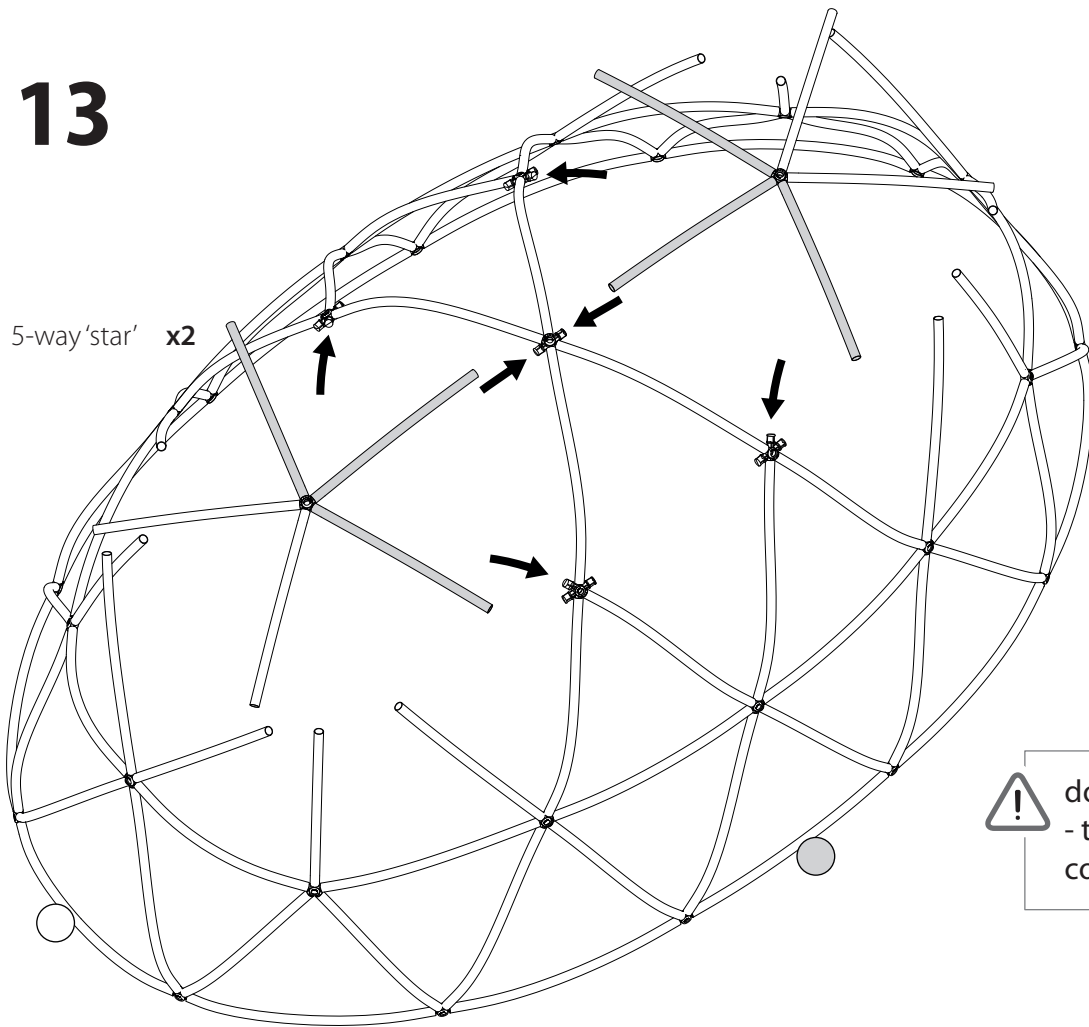

! do not over-bend pipes
- this can damage
connectors

14

long pipes (62cm) x6

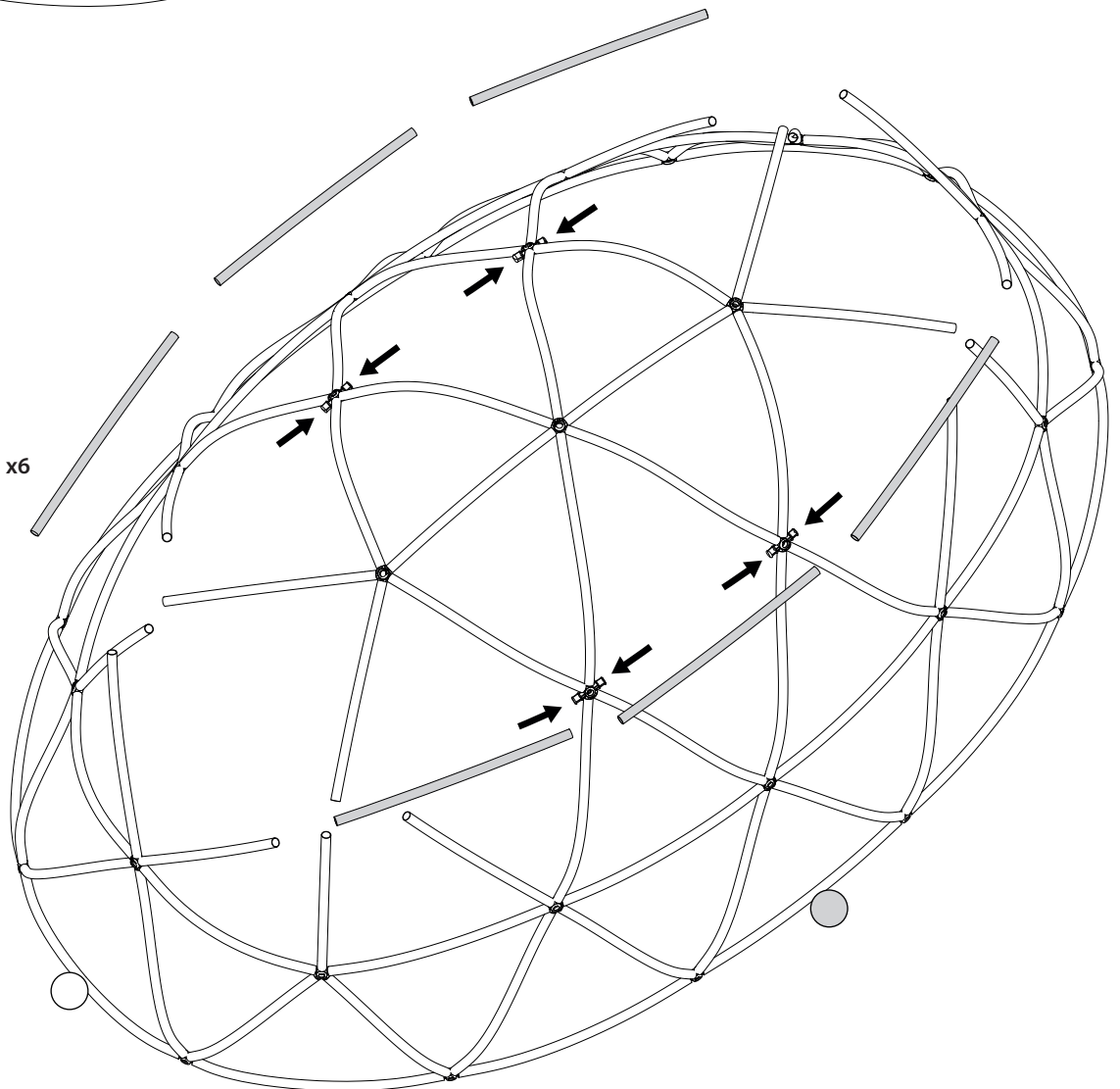

15

6-way connector x4

long pipes (62cm) x2

x2

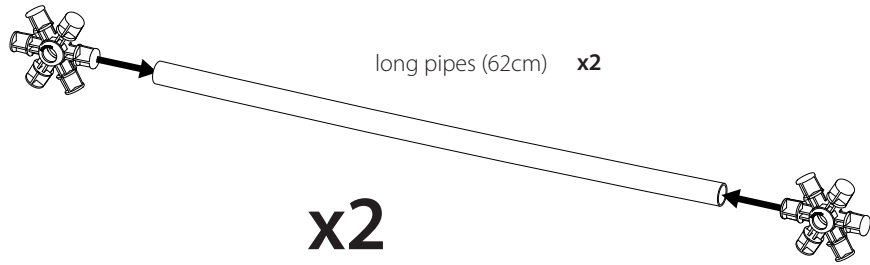

16

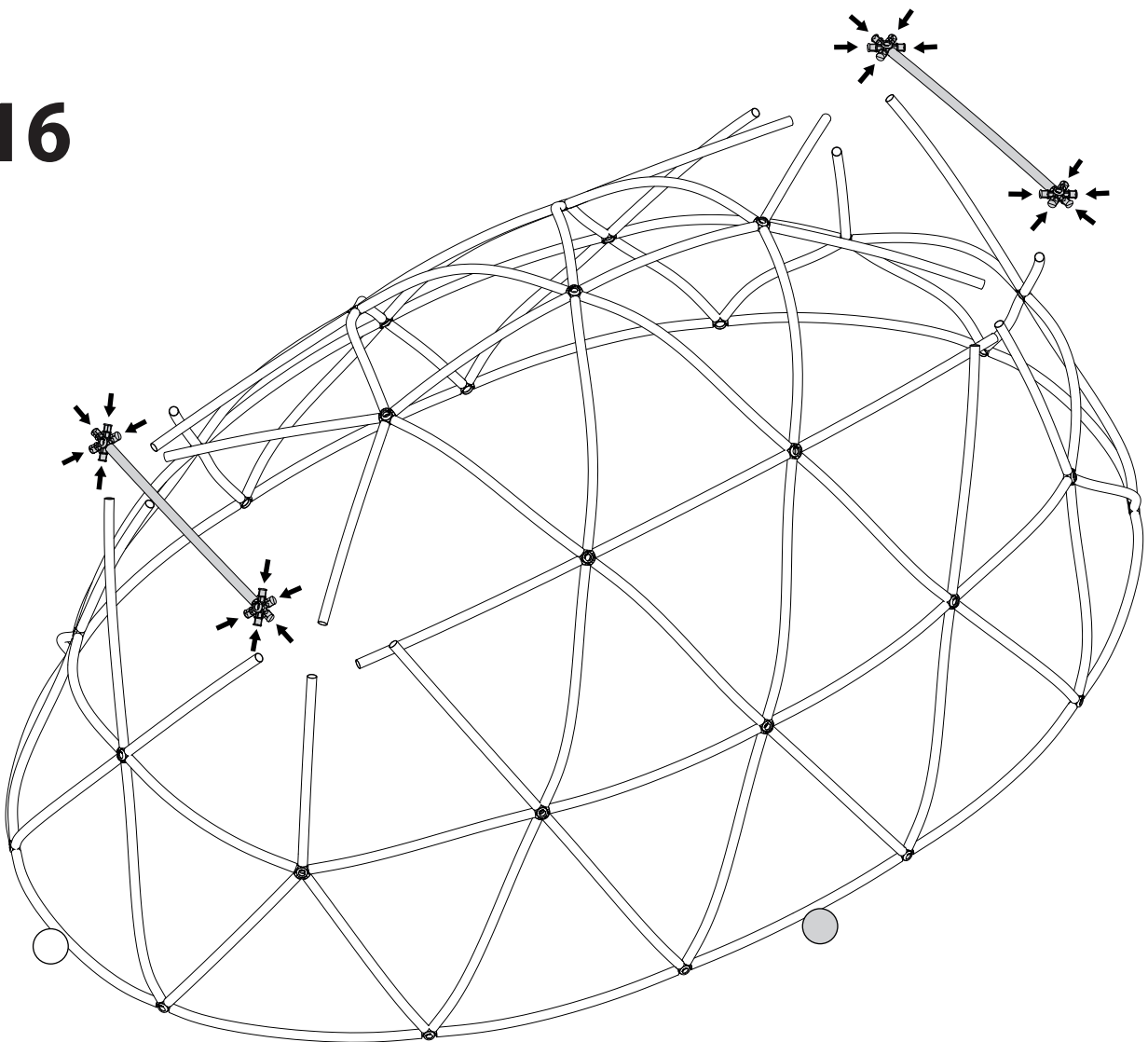

17

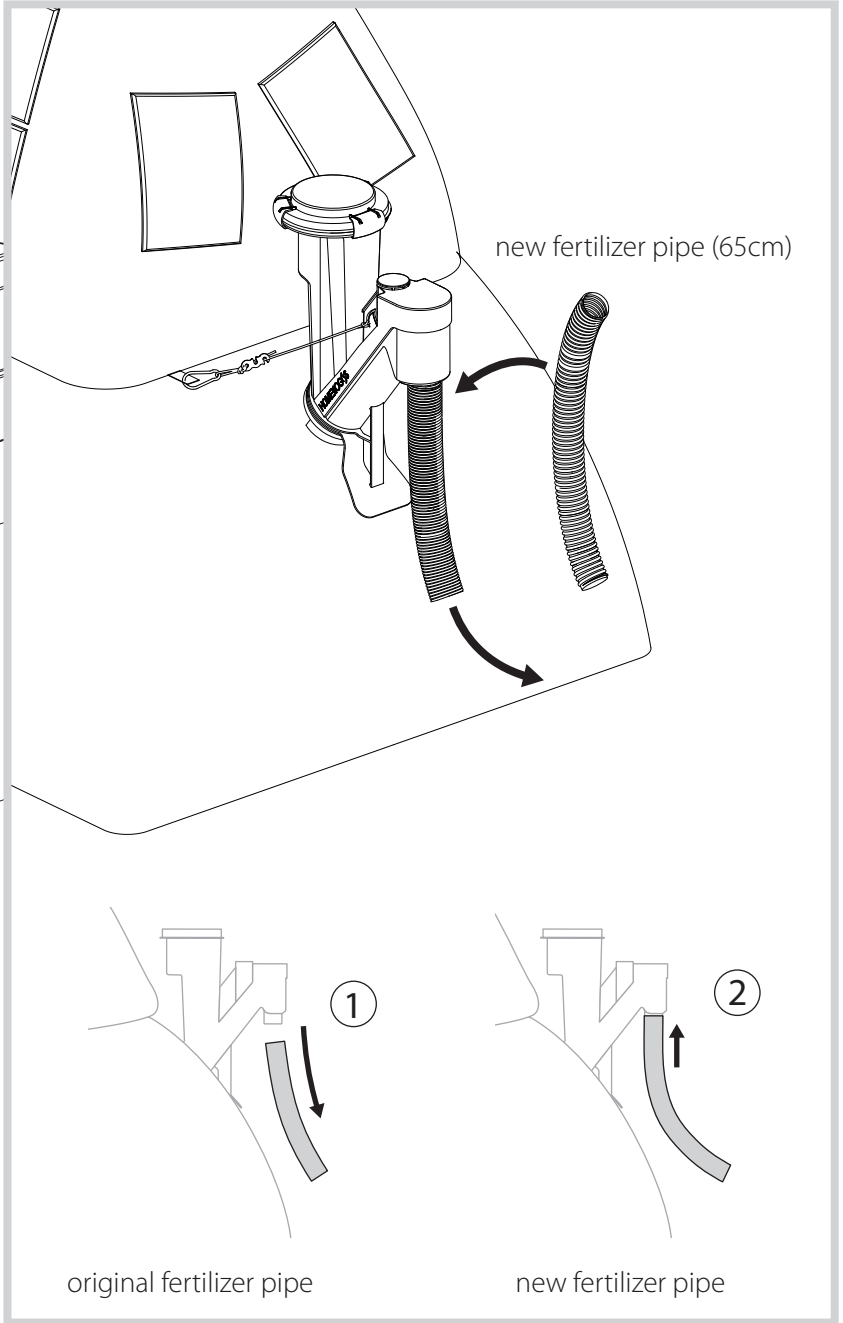

18

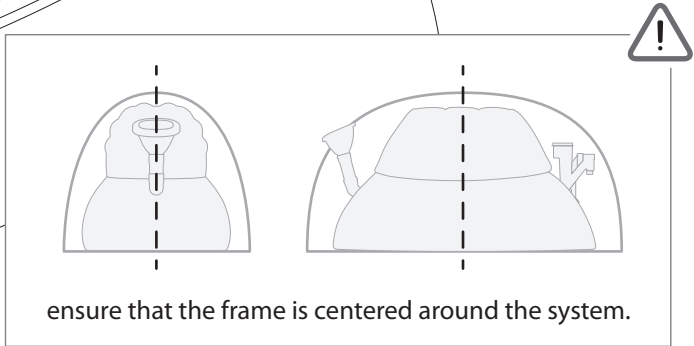
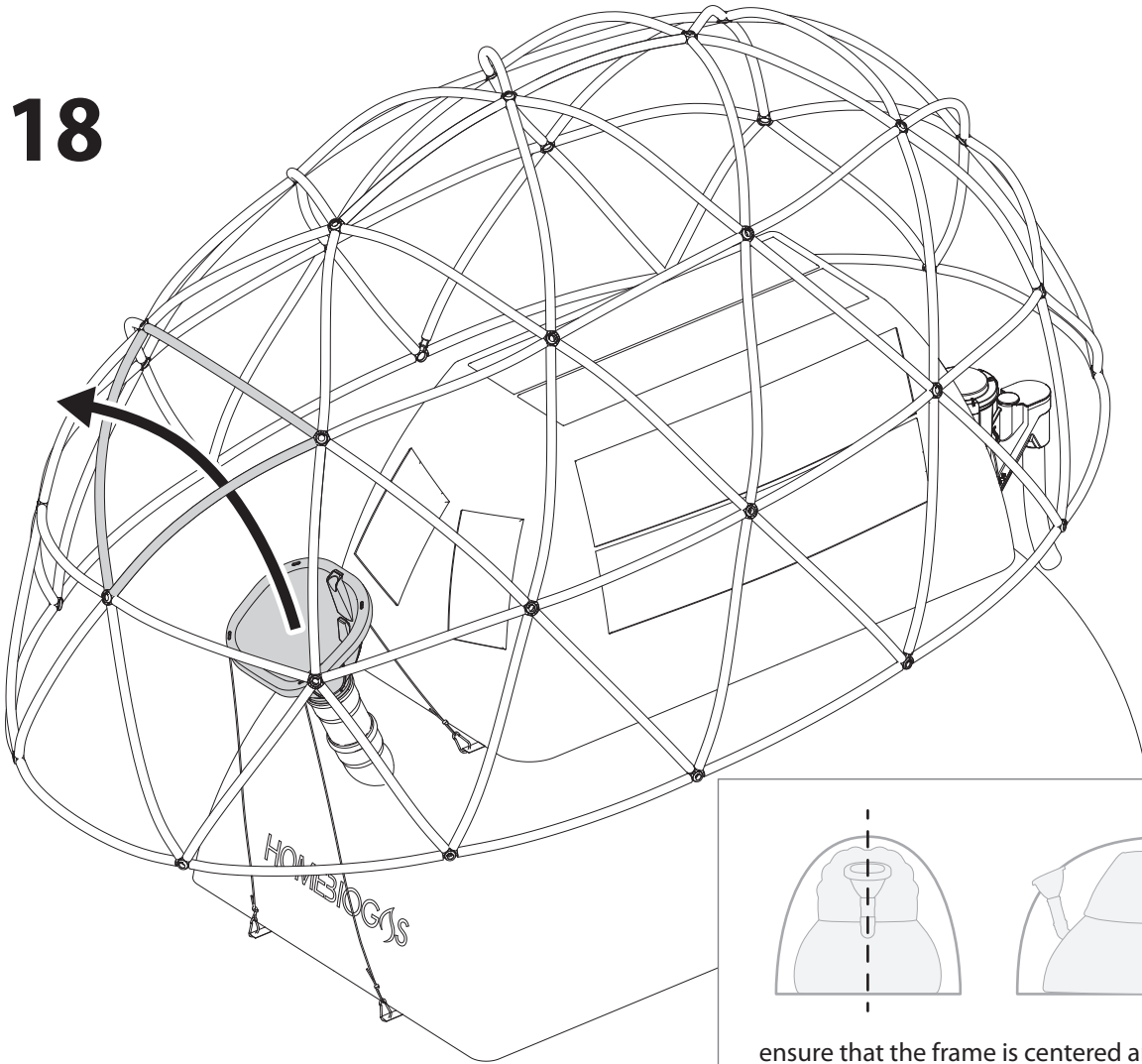

19

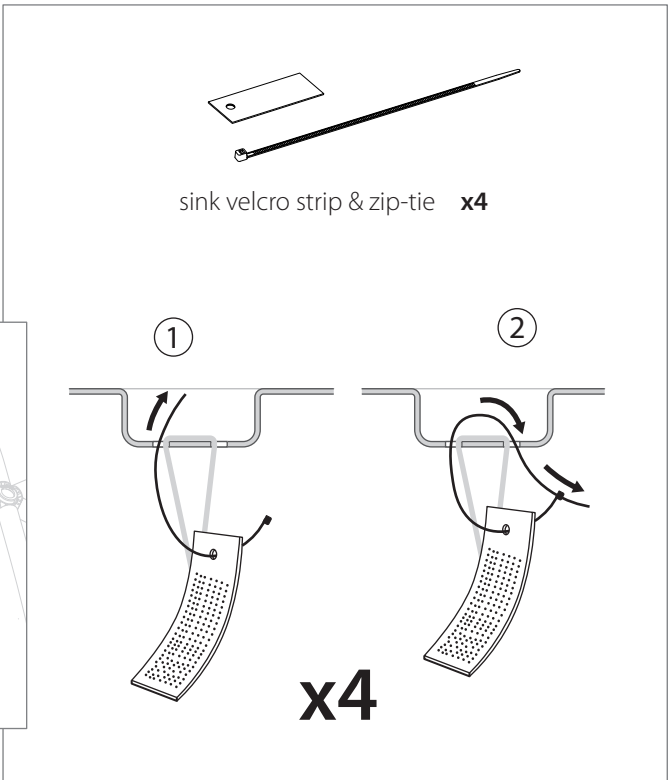
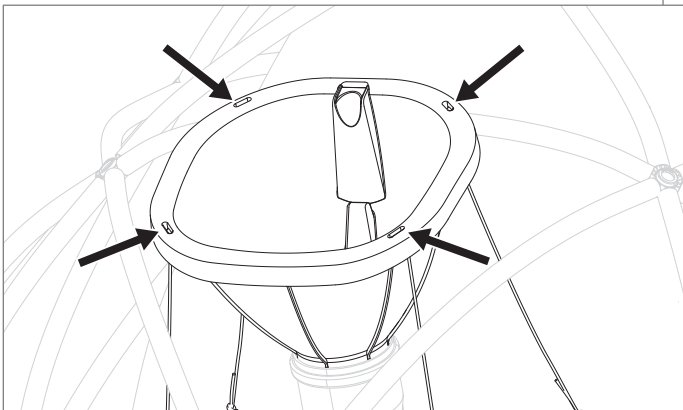



fertilizer pipe support strap

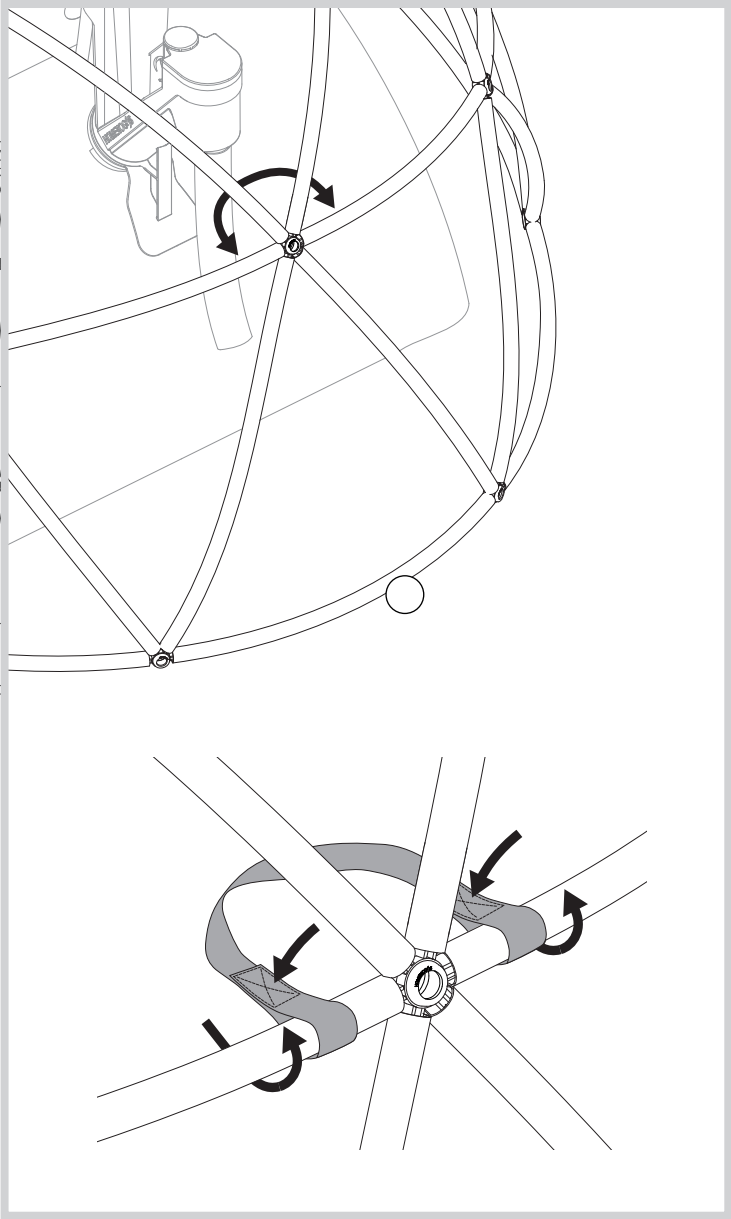
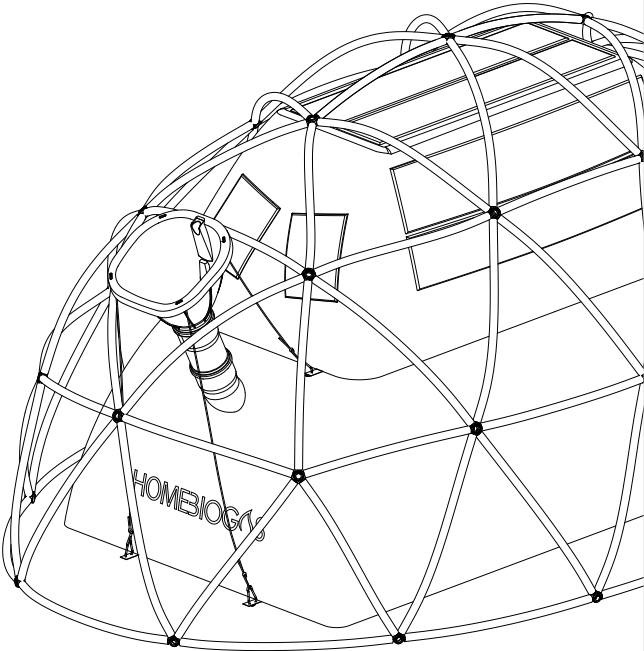

21

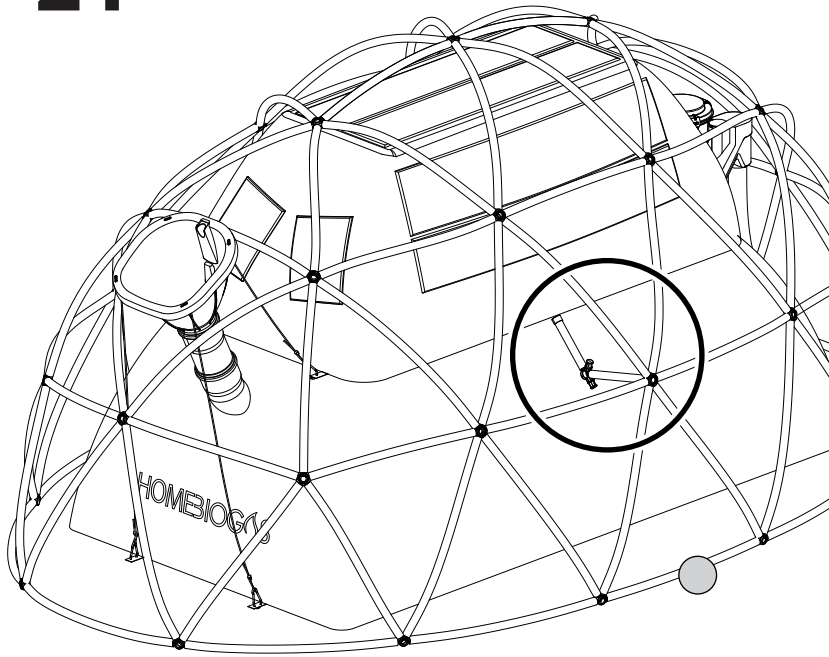

i Side braces help to secure the Thermo-Shield in place even in extreme weather conditions

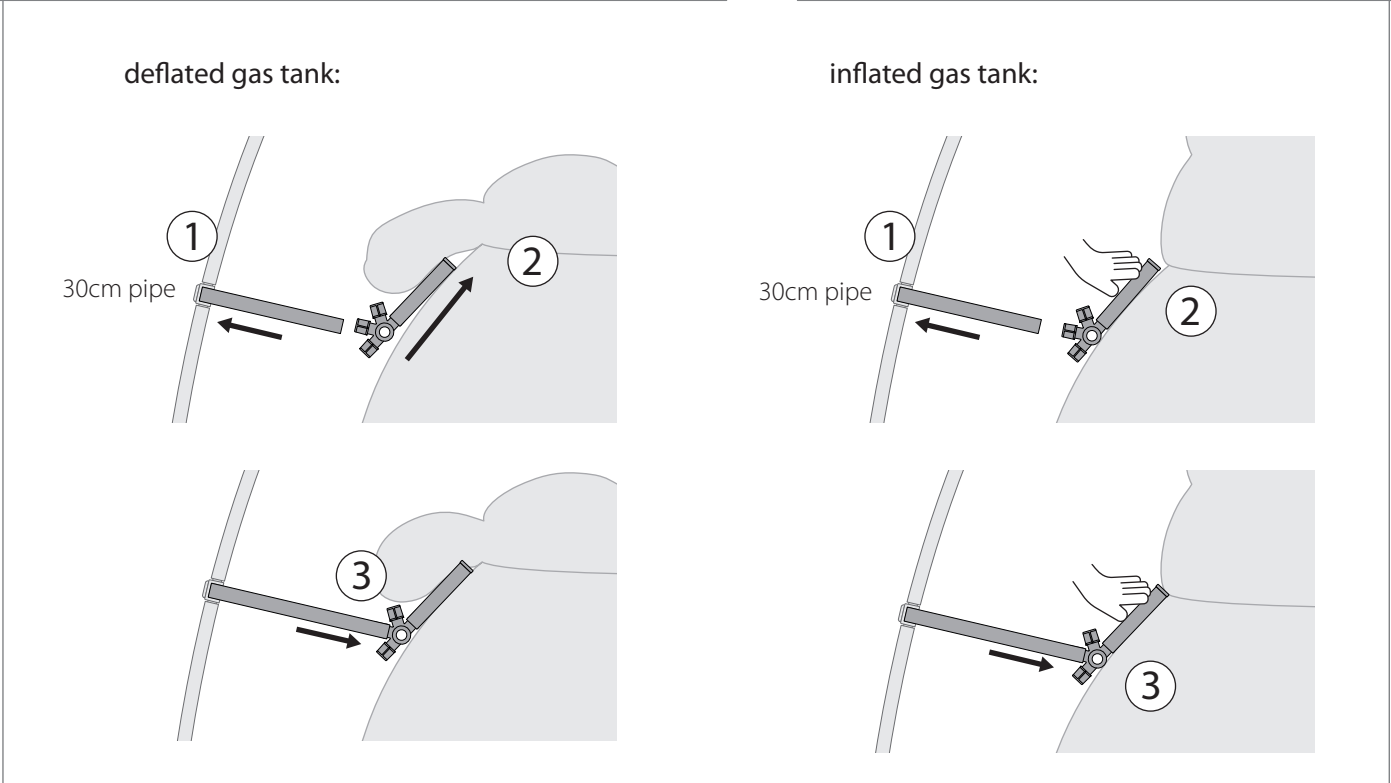
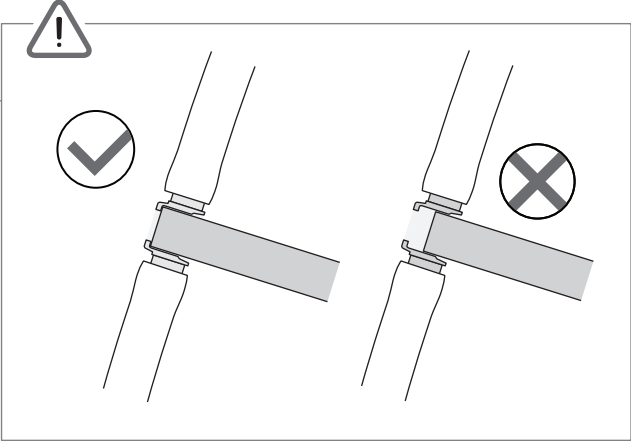
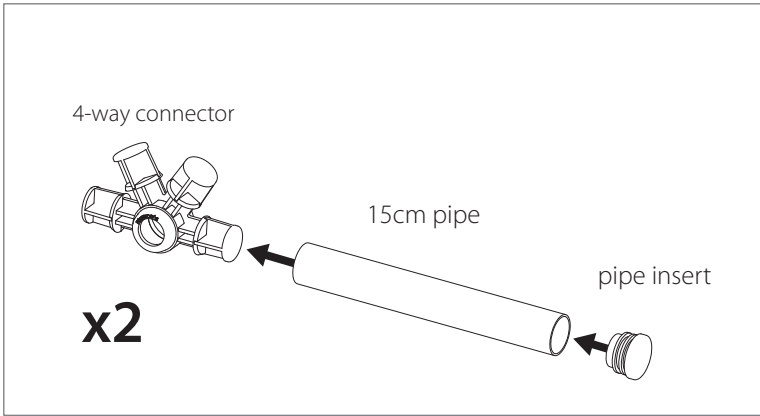
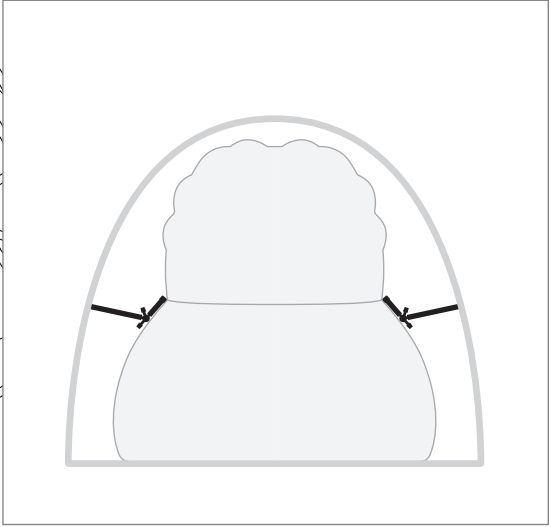

22

Thermo-Shield Cover

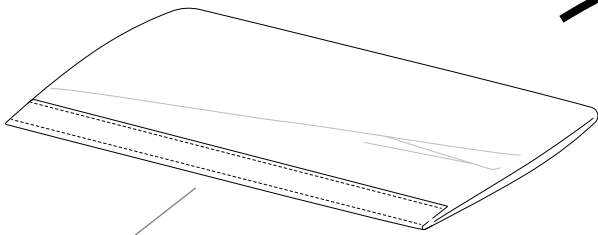

i remove paper liners from cover

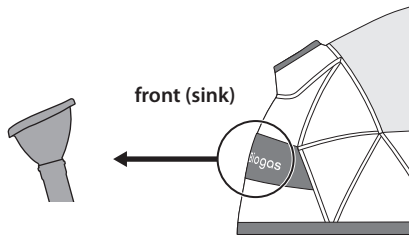
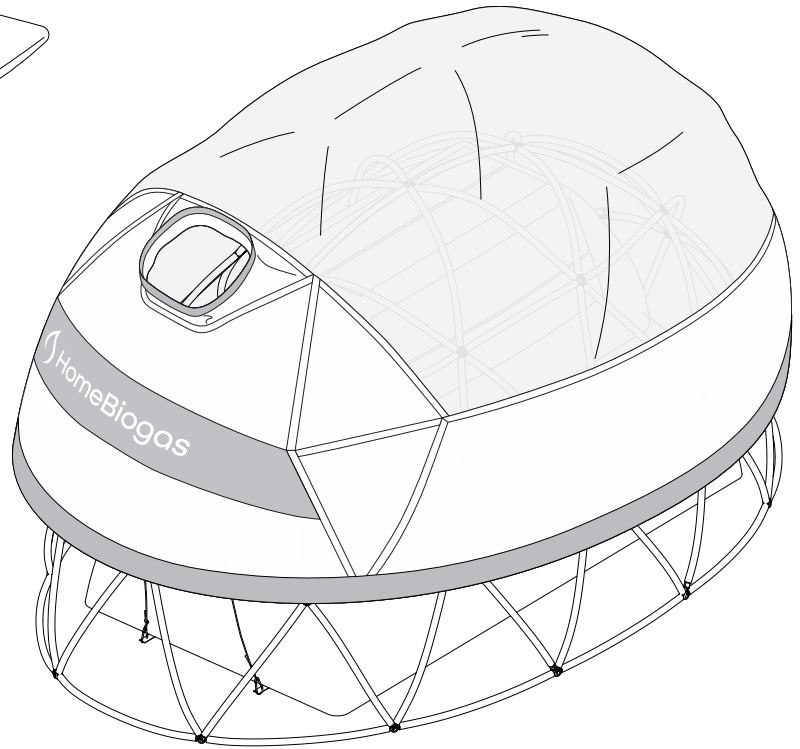

front (sink)

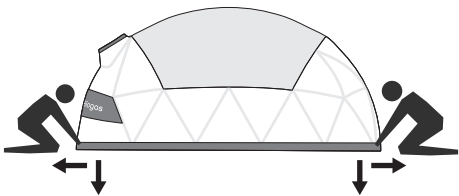
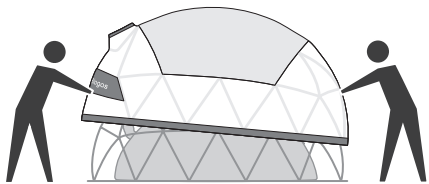

23

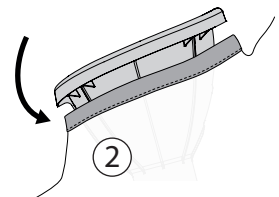
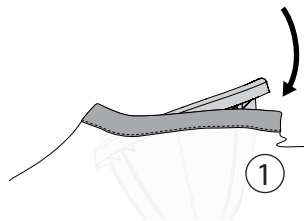

x4

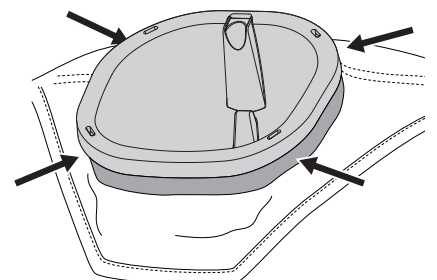
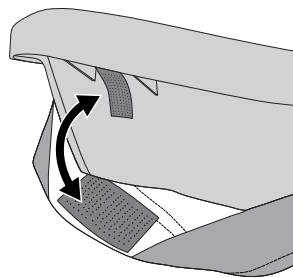

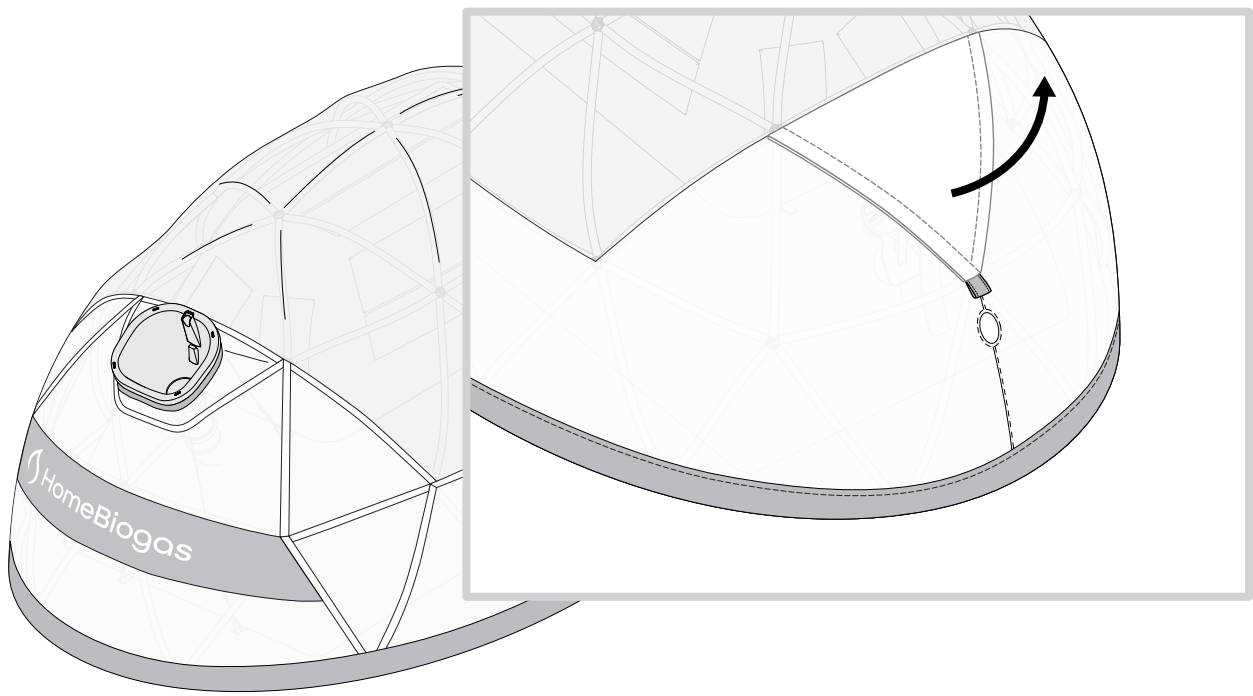

24

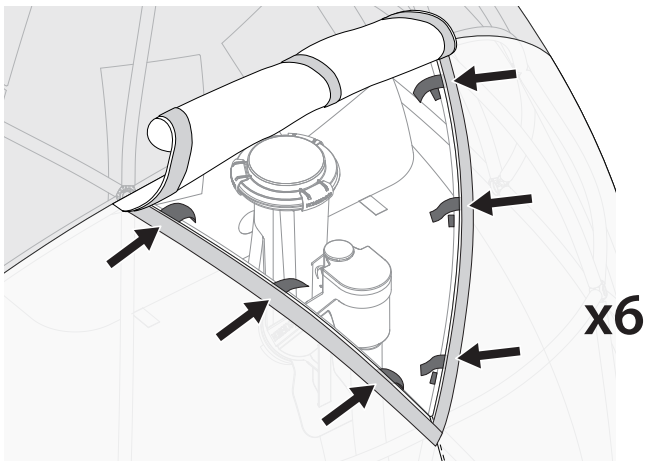

25

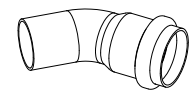
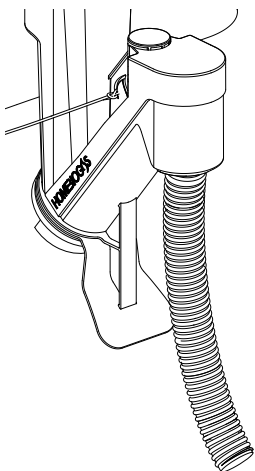

fertilizer pipe elbow

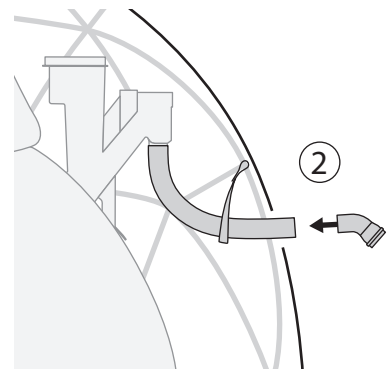
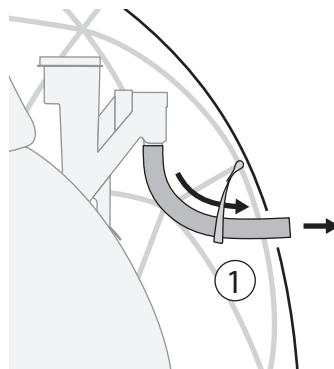



ensure cover seams are aligned with the frame below

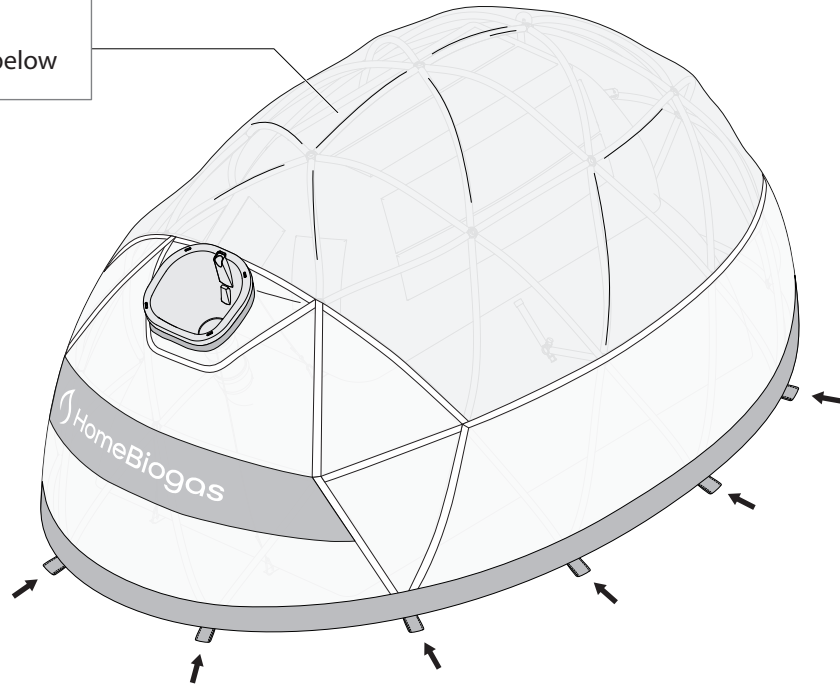

26

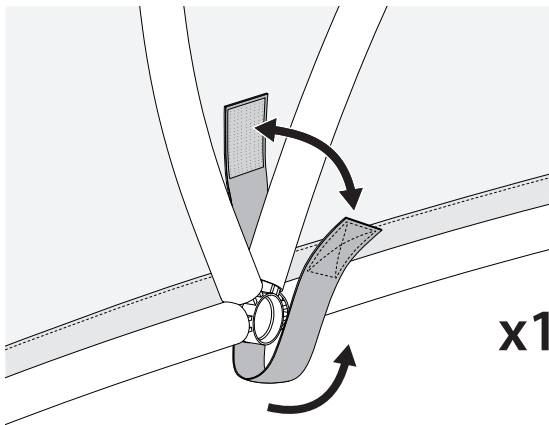

x12

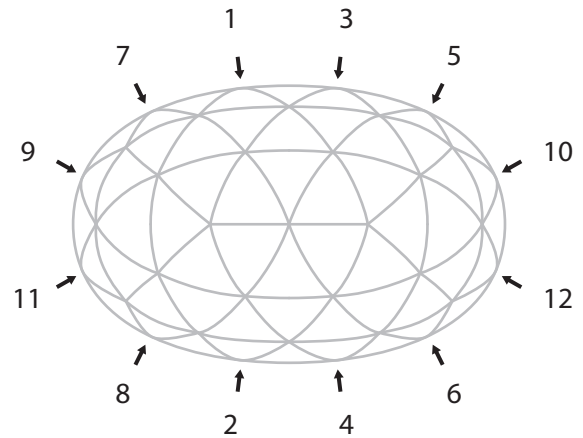

i pull hard before fastening velcro - straps should be tight

27

cover peg **x6**

